

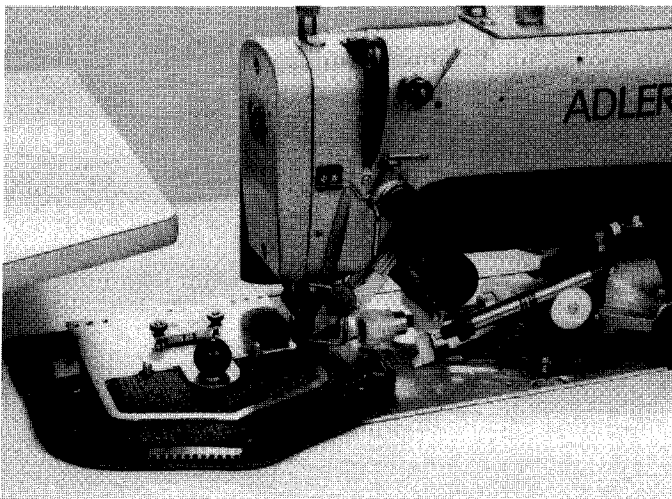

Teileliste und Näheinrichtungen
Spare Parts List and Sewing Equipment

961-23-4/0



Typenschlüssel:		z.B.	961	-	23	-	4/0
Machine Type code:							
Code du type:							
Clave de tipos:							
Hauptklasse:	}						
Main Class:							
Classe principale:							
Clase principal:							
Typ:	Schablonen Nähanlage						
Type:	Template sewing device						
Variant:	Equipement de couture avec Patron (à piquer)						
Variante:	Instalación de coser con Plantillas						
Mechanische Ausführung:	}						
Mechanical version:							
Equipement mécanique:							
Versión mecánica:							
Elektrische Ausführung:	3x380 V,	50 Hz, mit Mp = 0	}				
Ausführung:	3x220 V,	60 Hz,		= 1			
Electrical version:	3x220 V,	50 Hz,		= 2			
	3x400-440 V,	50 Hz,		= 3			
	3x190-240 V,	60 Hz,		= 4			
Constructions pour courant à:	3x190-240 V,	50 Hz,		= 5			
	3x346 V,	50 Hz,	= 6				
Datos eléctricos:							

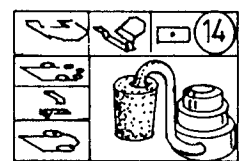
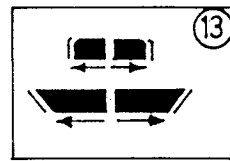
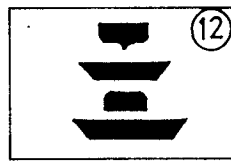
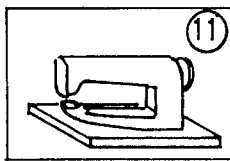
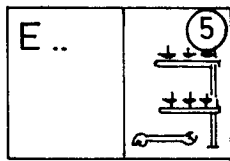
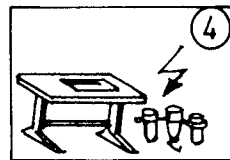
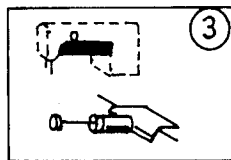
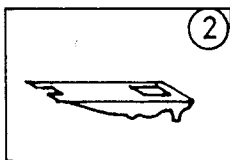
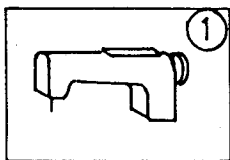
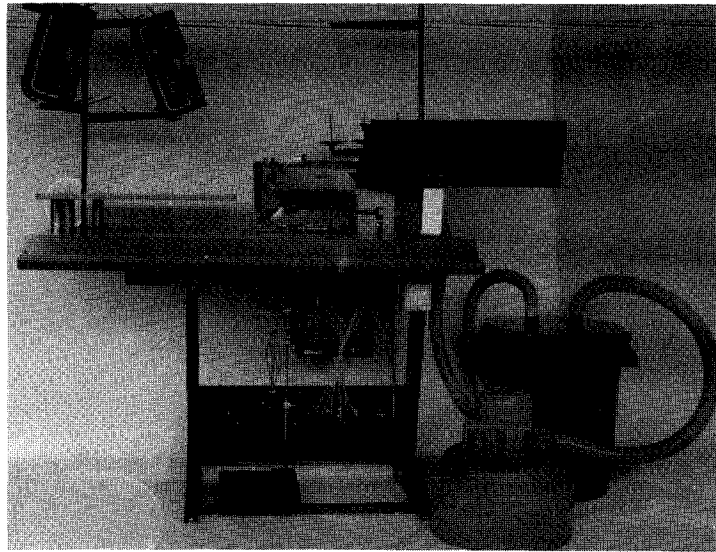

INFORMATION ZUR HANDHABUNG DER TEILELISTE

1. Allgemeines

1.1 Im Inhaltsverzeichnis sind die Teile-Nr. nach steigenden Nr. geordnet.

1.2 Teile-Nr. 993 91 081 7 Zyl.-Schr. M4 x 10 2 - B 10
 Benennung _____
 Abmessung _____
 Bildtafel Nr. (rechts und links oben in der Bildtafel eingekreiste Nr.) _____
 Planquadrat der jeweiligen Bildtafel _____

1.5 Zu einer Einheit gehörende Einzelteile sind durch eine strichpunktierte Linie eingerahmt. Die Einheit kann auch komplett unter der voll eingerahmten Teile-Nr. bestellt werden. Zu dieser Einheit gehören keine Teile, deren Nr. außerhalb der strichpunktierten Linie steht.

2.1 Verwendete Bildzeichen

N = nicht als Einzelteil lieferbar

Mg = mustergebunden, bei Ersatzteilebestellung bitte Muster einschicken oder Form-Nr. angeben

☞ = siehe Mechanikeranleitung

☑ = flüssig sichern, kleben, dichten
 Loctite 270, Nr.990 49 034 6



= Länge oder Fläche



= ohne Fadenabschneider



= mit Fadenabschneider



= links



= rechts

☛ = Hinweis auf Unterscheidungsmerkmal

mm = Maße

V = veraltete Ausführung

d.W. = auf Wunsch

2.3 Sollten Sie ein Teil nicht in der Ersatzteilliste auffinden, was durch technische Änderungen vorkommen kann, dann geben Sie uns bitte zur Teile- und Funktionsbeschreibung, evtl. Teil skizzieren, die genaue Unterklasse und Fabrik-Nr. lt. Typenschild bekannt.

3. Elektro-Teile

3.1 Bei Elektrokabeln und pneumatischen Schläuchen ist es erforderlich, die gewünschte Meterzahl anzugeben.

3.2 Bei Bestellungen von Elektroteilen bitten wir die zusätzlichen Angaben, die in Klammern hinter der Teile-Nr. stehen, mit anzugeben.

3.3 Elektroteile sind zum schnellen Auffinden im Lageplan mit einer Positions-Nr. gekennzeichnet. Die Teile sind wie in Punkt 1.5 beschrieben aufgeführt.

3.4 Nicht numerierte Elektroteile können nach der Bezeichnung z.B. "Transistor T6" oder "Widerstand 1K 0,5W" und der dazugehörigen Stromlaufplan-Nr. bestellt werden.

5. Jeder Nachdruck, auch der auszugsweise, ist nur mit unserer Genehmigung gestattet. Änderungen behalten wir uns vor.

Bildtafel ①+②+③: **1**
396 99 013 3
396-A2-DVWF

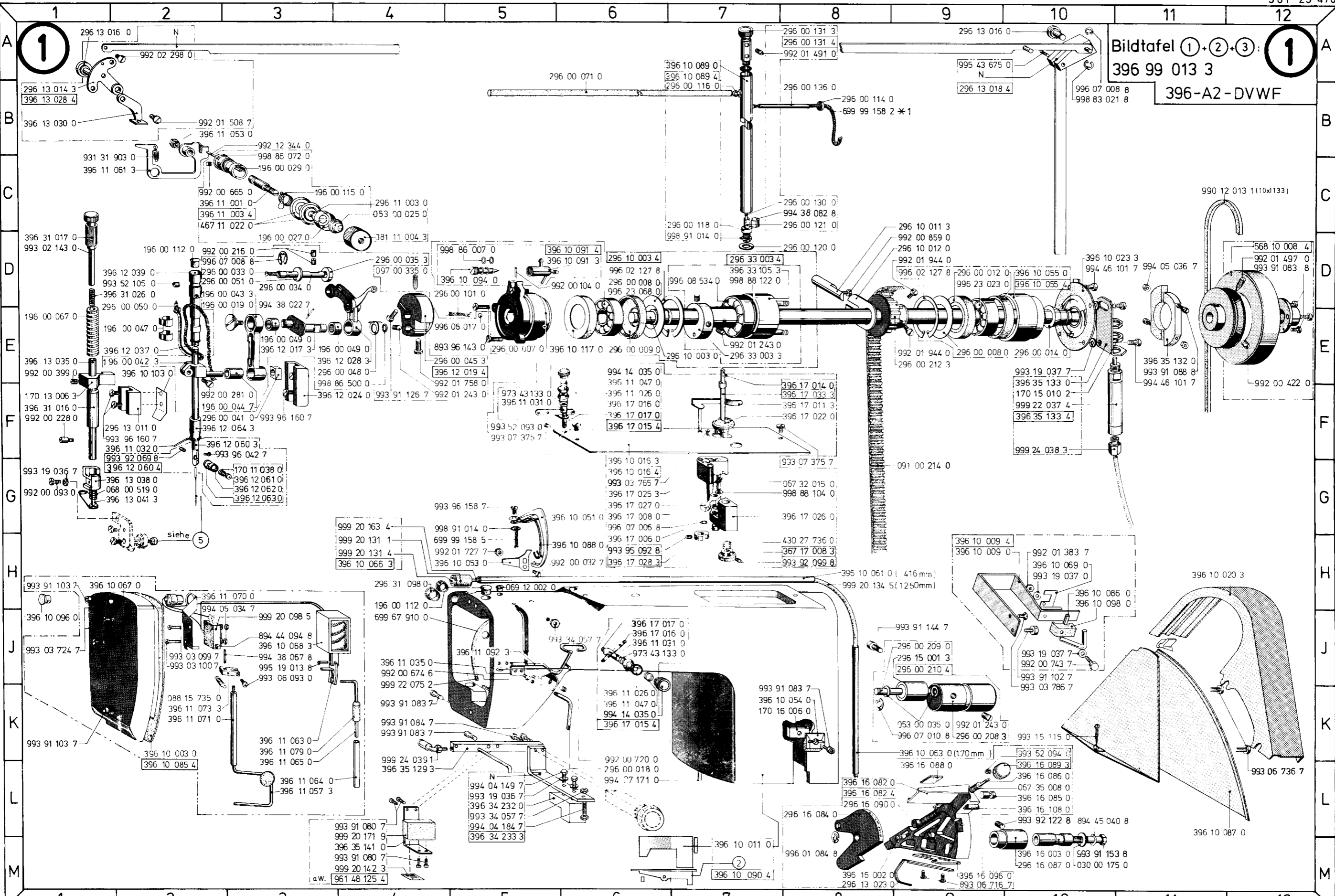

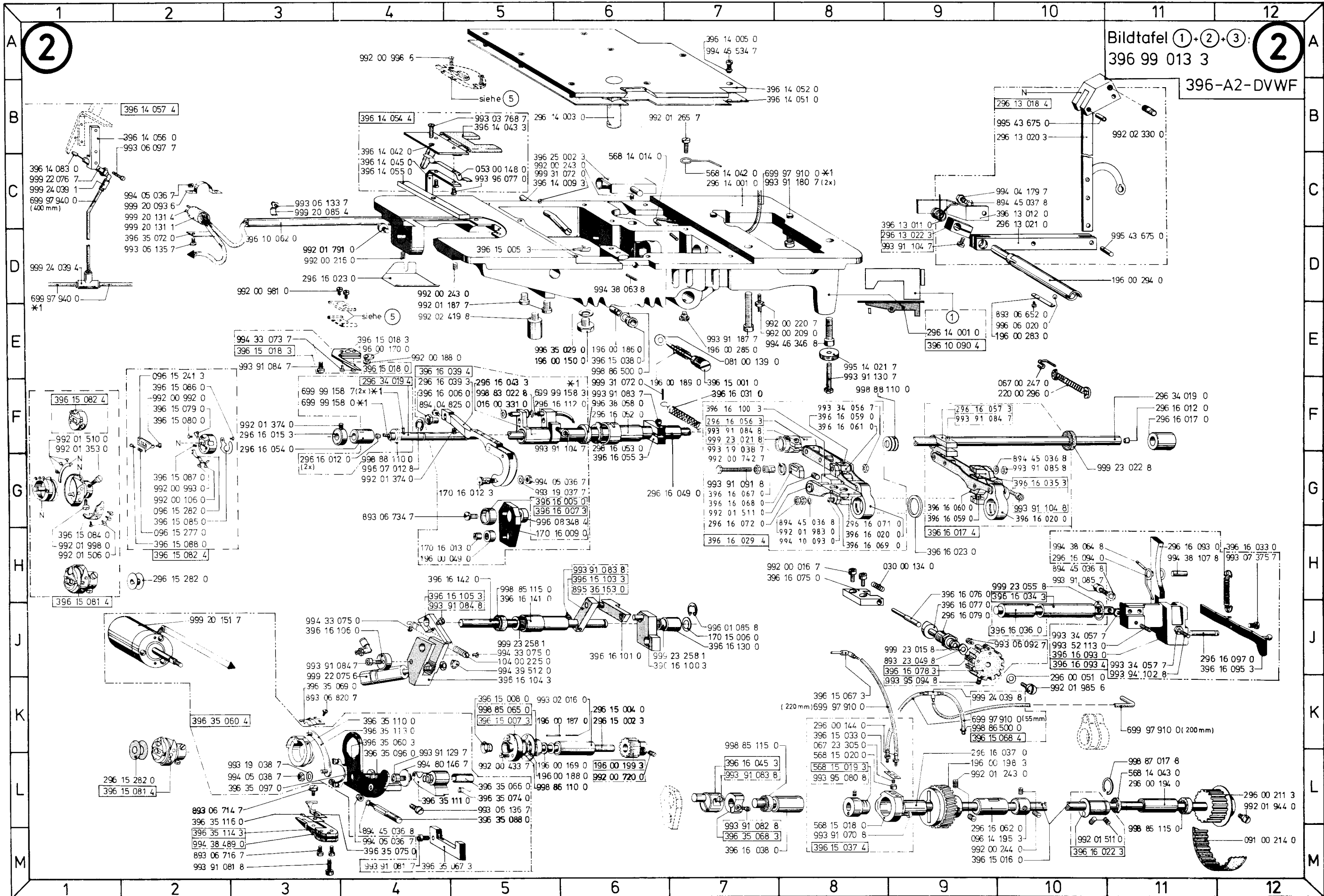

Bildtafel ①+②+③:
396 99 013 3
396-A2-DVWF

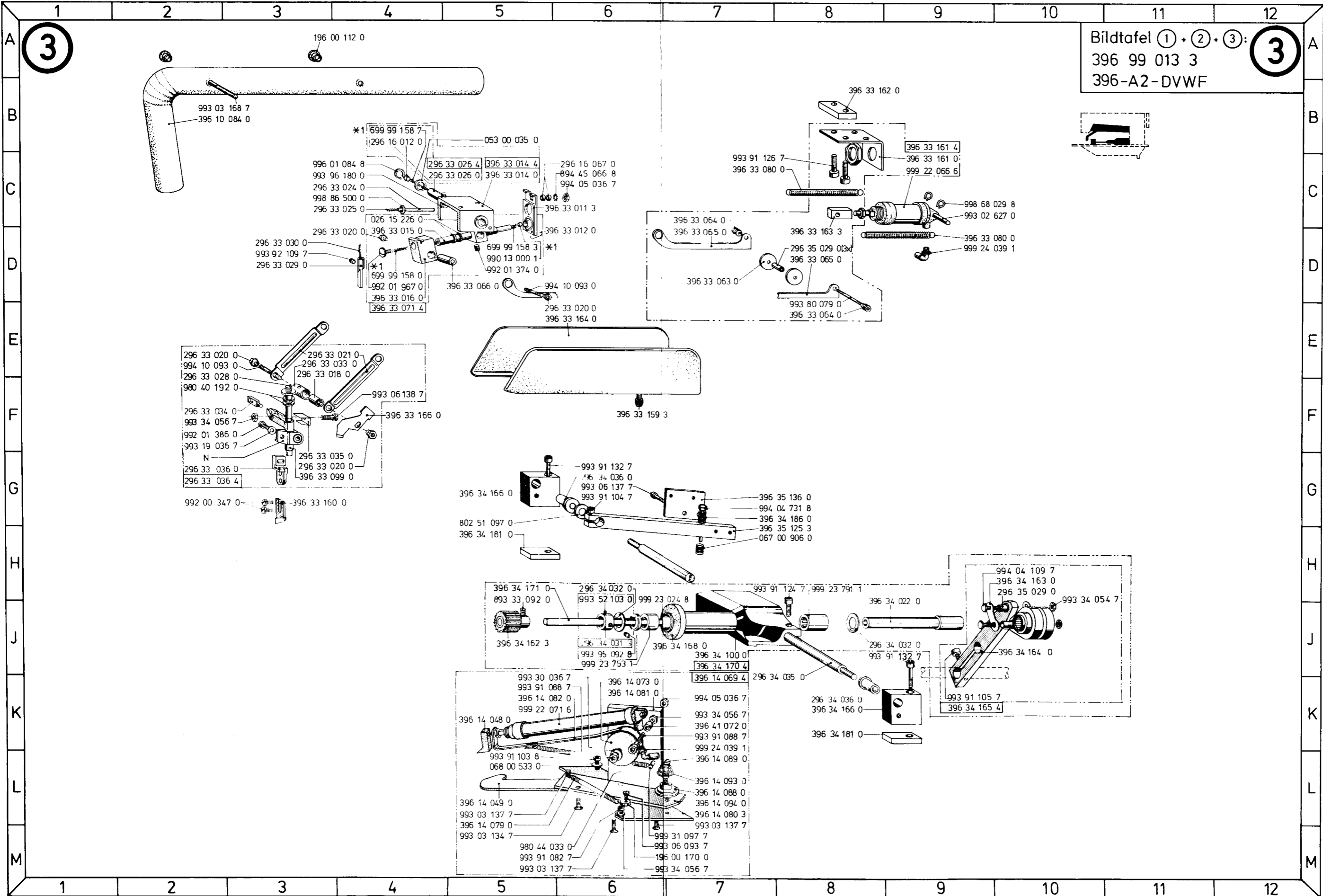

Bildtafel ① + ② + ③: **3**
 396 99 013 3
 396-A2-DVWF

*1 = Länge angeben
 = Declar length

© C. 6. 78/HK.2.81/11.82 JT.2.86 JT.4.89

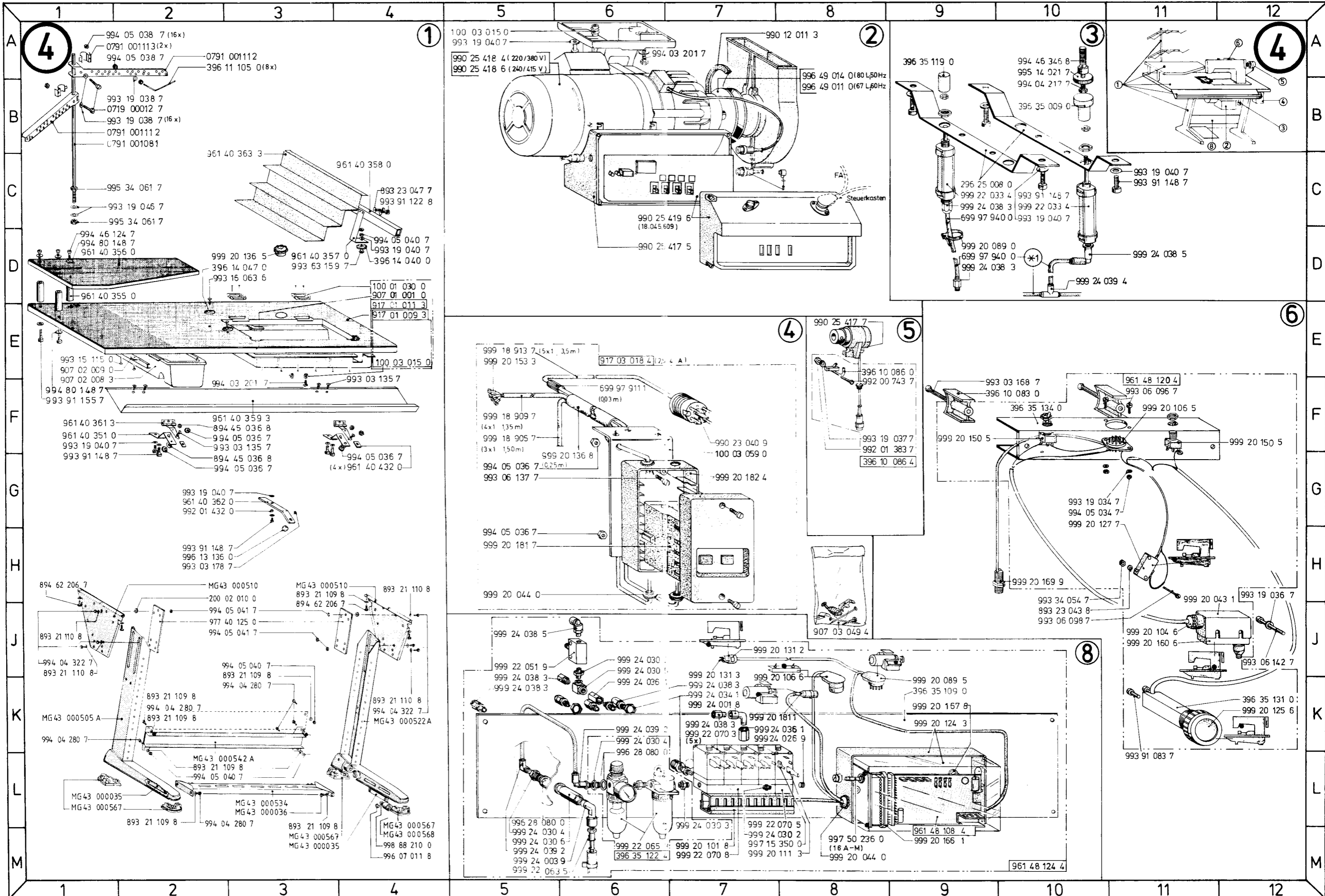

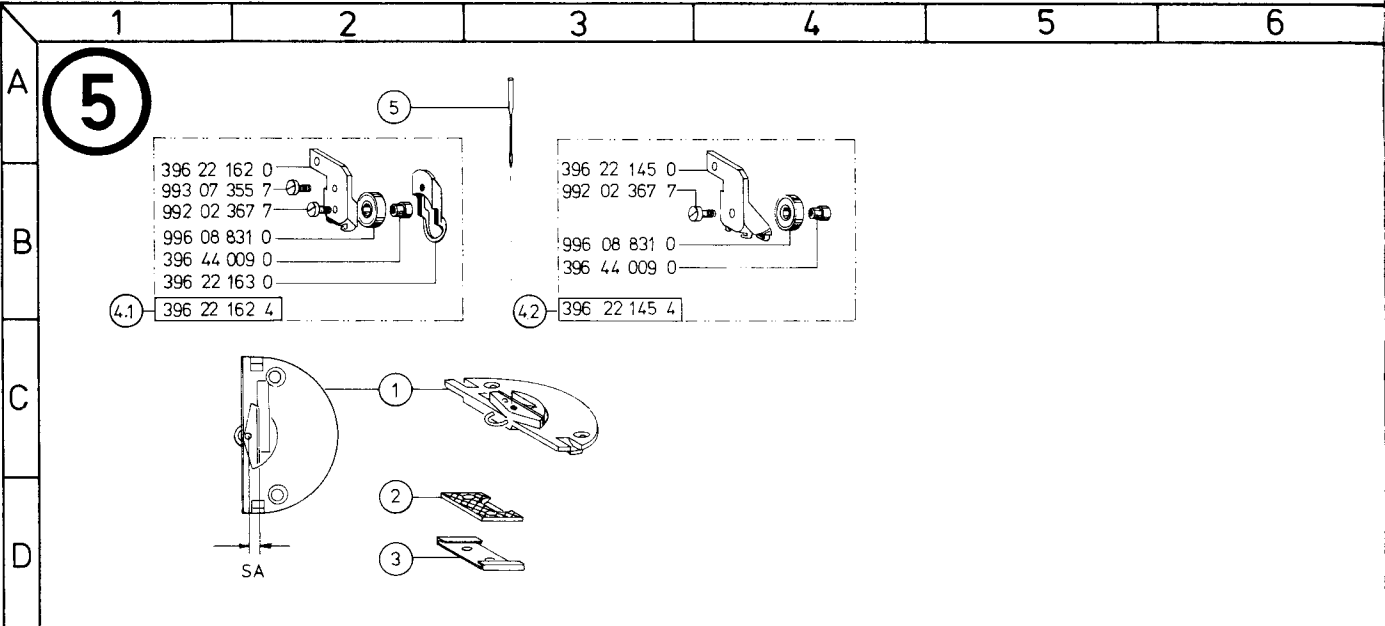

E Nr.	①	SA mm	②	③	④	⑤
K 961 E10	396 20 071 3	3	396 21 023 0	396 21 024 0	396 22 162 4	4.1 396 22 145 4 4.2 134-35/90
K 961 E11	396 20 039 3	4	396 21 023 0	396 21 024 0	396 22 162 4	4.1 396 22 145 4 4.2 134-35/90
E 961 E12	396 20 044 3	5	396 21 023 0	396 21 024 0	396 22 162 4	4.1 396 22 145 4 4.2 134-35/90

E Nr. K 961...	NÄHEINRICHTUNGEN FÜR KL. 961-23-4 Verwendungszweck	SEWING EQUIPMENT FOR CL. 961-23-4 Use
E 11	Näheinrichtung für schablonengesteuertes Nähen und Beschneiden, Schneidabstand 4 mm, mit Rollfuß zum Vornähen und Beschneiden, Absteppen normaler Ware (Maschinenausrüstung). Ein Rollfuß zum Vornähen und Beschneiden (nicht zum Absteppen geeignet) flauschiger Ware wird der Maschine beigelegt, Nadelstärke Nm 90-110, Stichtlänge max. 4 mm	Sewing equipment for template-controlled sewing and trimming, cutting distance 4 mm, with roller foot for runstitching and trimming, topstitching of normal material (machine equipment). One roller foot for runstitching and trimming of soft material, such as flannel, will be supplied with the machine (not suitable for topstitching). Needle sizes Nm 90-110, stitch length up to 4 mm
E 10	Näheinrichtung für schablonengesteuertes Nähen und Beschneiden, Schneidabstand 3 mm, mit Rollfuß zum Vornähen und Beschneiden, Absteppen normaler Ware (Maschinenausrüstung). Ein Rollfuß zum Vornähen und Beschneiden (nicht zum Absteppen geeignet) flauschiger Ware wird der Maschine beigelegt, Nadelstärke Nm 90-110, Stichtlänge max. 4 mm	Sewing equipment for template-controlled sewing and trimming, cutting distance 3 mm, with roller foot for runstitching and trimming, topstitching of normal material (machine equipment). One roller foot for runstitching and trimming of soft material, such as flannel, will be supplied with the machine (not suitable for topstitching). Needle sizes Nm 90-110, stitch length up to 4 mm
E 12	Näheinrichtung für schablonengesteuertes Nähen und Beschneiden, Schneidabstand 5 mm, mit Rollfuß zum Vornähen und Beschneiden, Absteppen normaler Ware (Maschinenausrüstung). Ein Rollfuß zum Vornähen und	Sewing equipment for template-controlled sewing and trimming, cutting distance 5 mm, with roller foot for runstitching and trimming, topstitching of normal material (machine equipment). One roller foot for

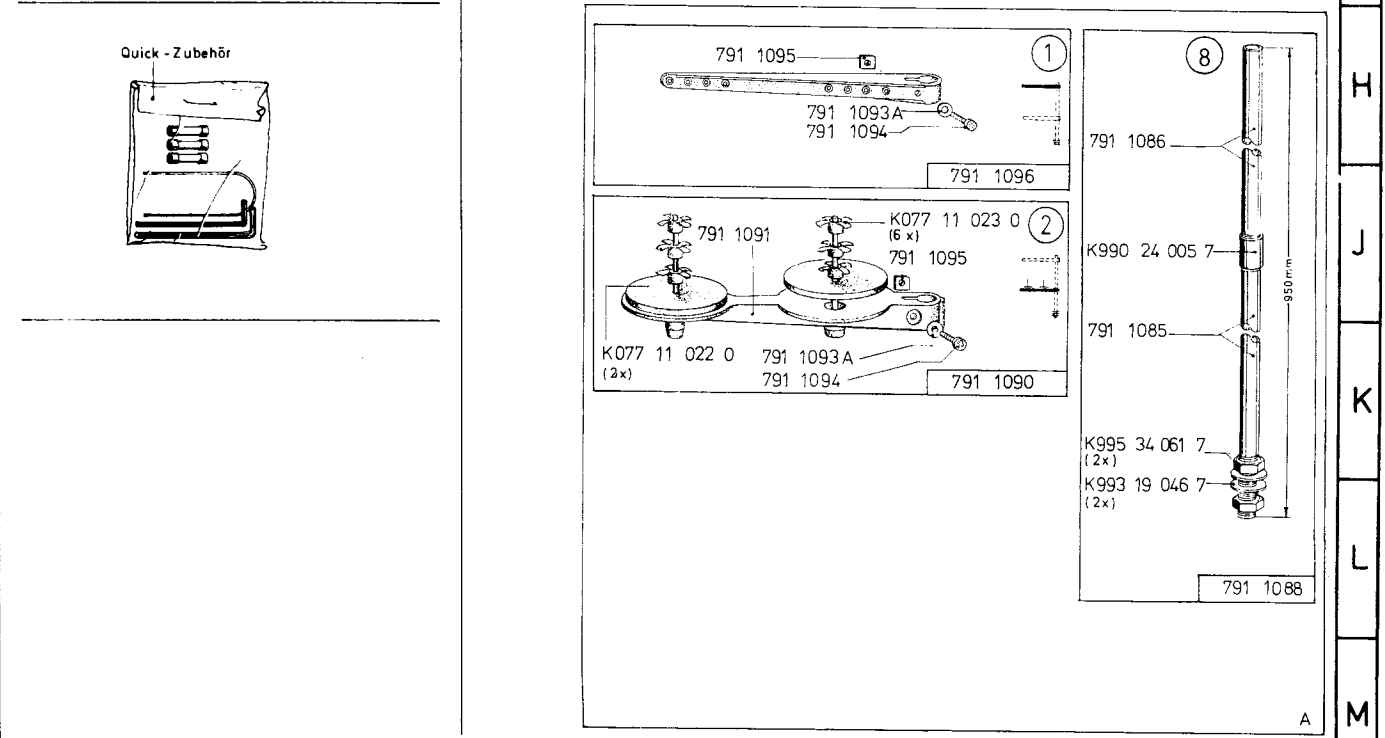
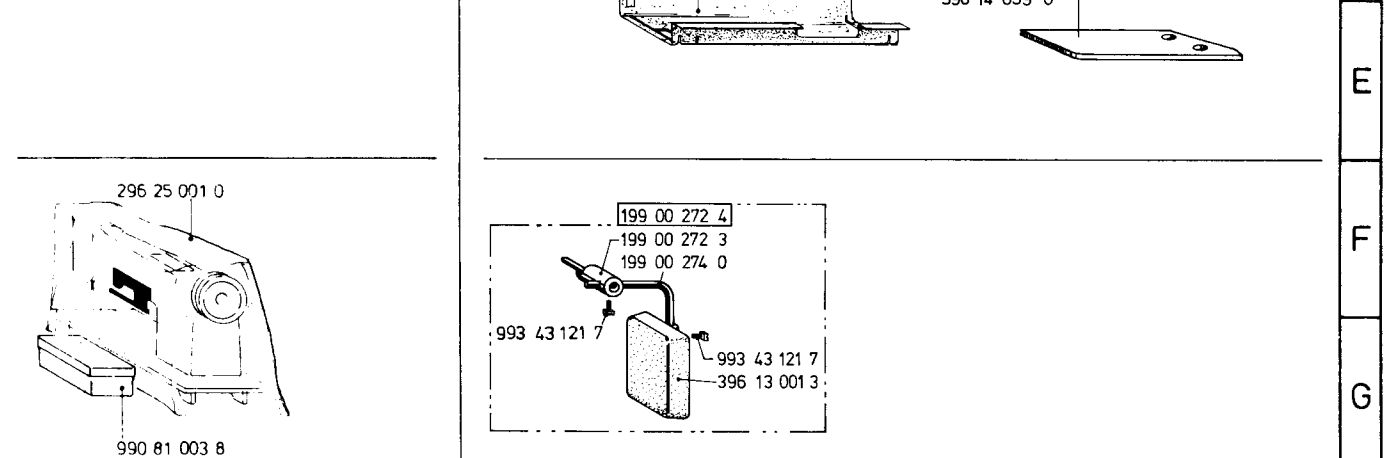
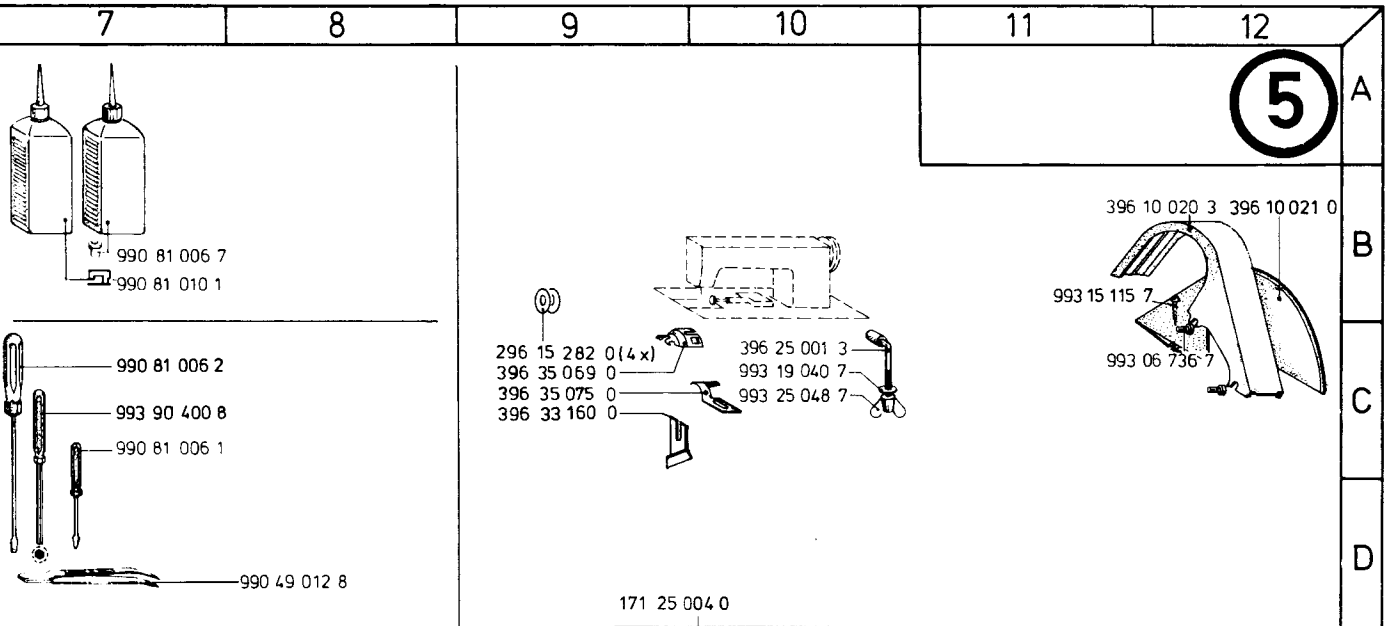

961-SS1
961 44 751 4

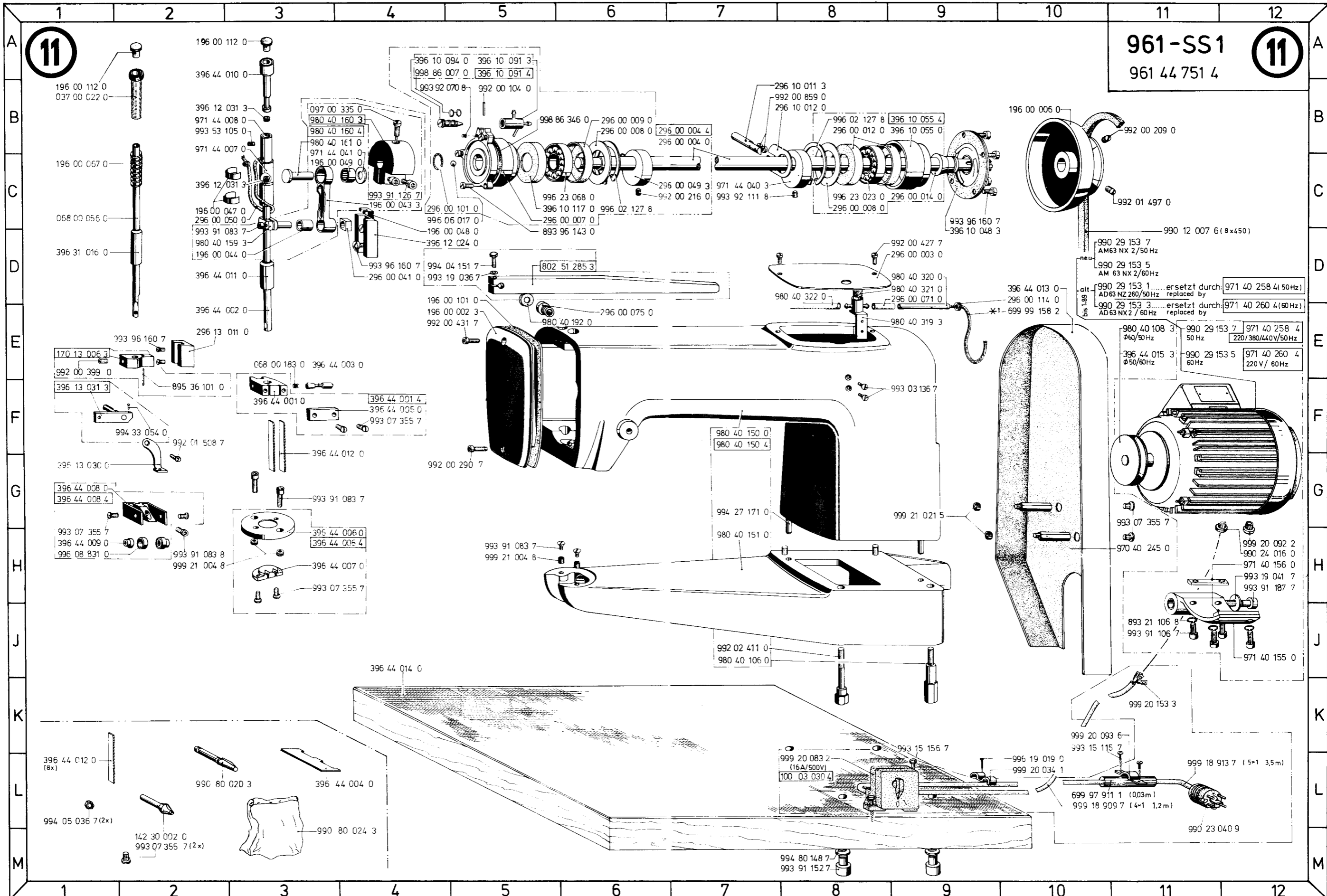

neu 990 29 153 7
 AM 63 NX 2/50 Hz
 990 29 153 5
 AM 63 NX 2/60 Hz
 alt 990 29 153 1 ersetzt durch 971 40 258 4 (50 Hz)
 AD 63 NZ 260/50 Hz replaced by
 990 29 153 3 ersetzt durch 971 40 260 4 (60 Hz)
 AD 63 NX 2 / 60 Hz replaced by

980 40 108 3 990 29 153 7 971 40 258 4
 φ60/50 Hz 50 Hz 220/380/440V/50 Hz
 396 44 015 3 990 29 153 5 971 40 260 4
 φ50/60 Hz 60 Hz 220 V / 60 Hz

*1 = Länge angeben
 = Declared length

Printed in West - Germany · Änderungen vorbehalten · TL 961-SS 1·4 4.1989

Fertigung des Nähguthalters durch den Kunden.

MANUFACTURE OF WORKPIECE CLAMP BY CUSTOMER

nicht verstellbarer Nähguthalter

WORKPIECE CLAMP NON-ADJUSTABLE

	Patten	Kragen	Manschetten	großer Kragen	Patten
	396 41 751 4	396 41 752 4	396 41 753 4	396 41 754 4	396 41 756 4
A	396 41 005 2 250 x 280mm	396 41 015 2 250 x 600mm	396 41 025 2 280 x 350mm	396 41 018 2 330 x 700mm	396 41 005 2 250 x 280mm
B	396 41 006 2 250 x 280mm	396 41 016 2 250 x 600mm	396 41 026 2 280 x 350mm	396 41 019 2 330 x 700mm	396 41 004 2 250 x 280mm
C	396 41 004 2 250 x 280mm	396 41 014 2 250 x 600mm	396 41 024 2 280 x 350mm	396 41 017 2 330 x 700mm	396 41 004 2 250 x 280mm

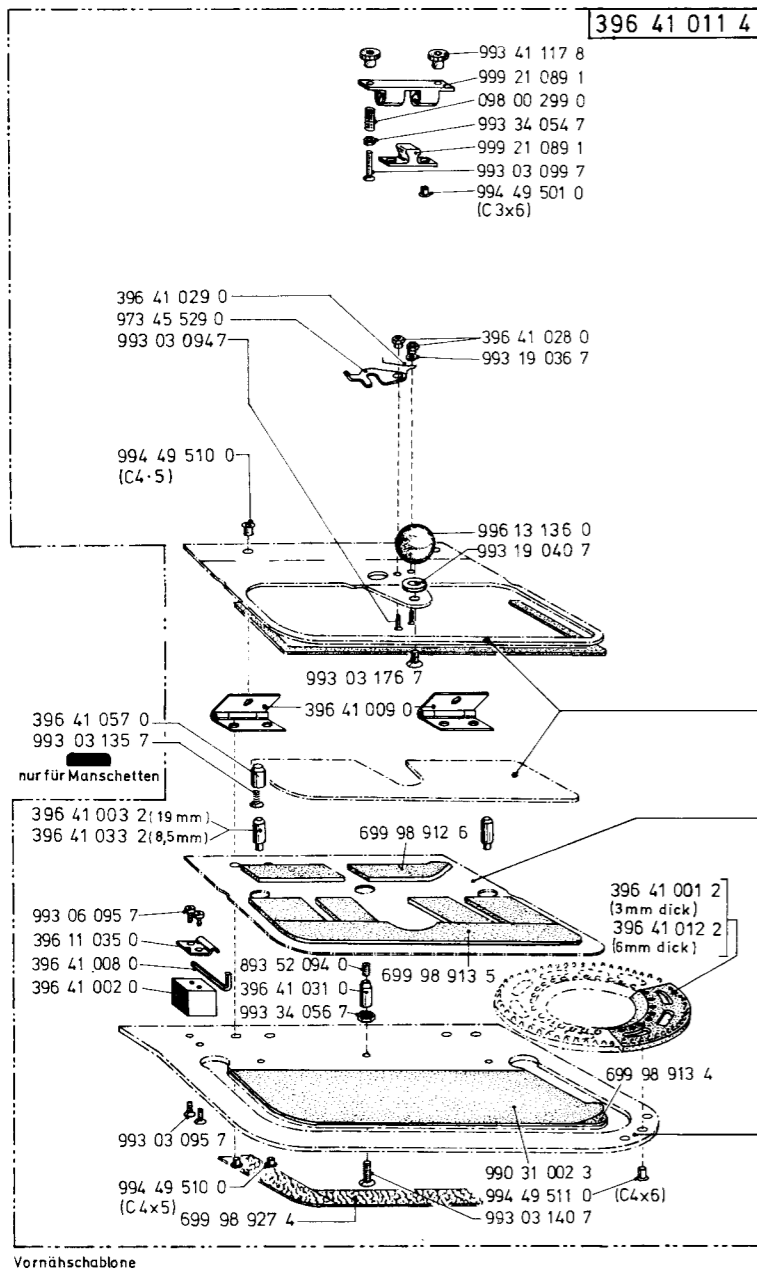

Zuschnitt- maße (mm) a · b	Nahtmaße (mm)		A	B	C
	j · h max	f · g max			
250 · 280	188 · 189	218 · 159	396 41 005 2	396 41 006 2	396 41 004 2
250 · 600	188 · 509	538 · 159	396 41 015 2	396 41 016 2	396 41 014 2
280 · 350	218 · 259	288 · 189	396 41 025 2	396 41 026 2	396 41 024 2
330 · 700	268 · 609	638 · 239	396 41 018 2	396 41 019 2	396 41 017 2
500 · 1000	438 · 909	938 · 409	396 41 081 2	396 41 082 2	396 41 080 2
1000 · 2000 Platten *			699 81 830 6 *	699 81 830 1 *	699 99 152 8 *

* werden andere Maße gewünscht, so ist dies bei der Bestellung anzugeben.

PLEASE, STATE IN CASE OF AN ORDER WHETHER OTHER DIMENSIONS ARE REQUIRED OR NOT

- A Al 1,5mm dick
- B Al 0,5mm dick
- C Hartgewebe 3mm dick

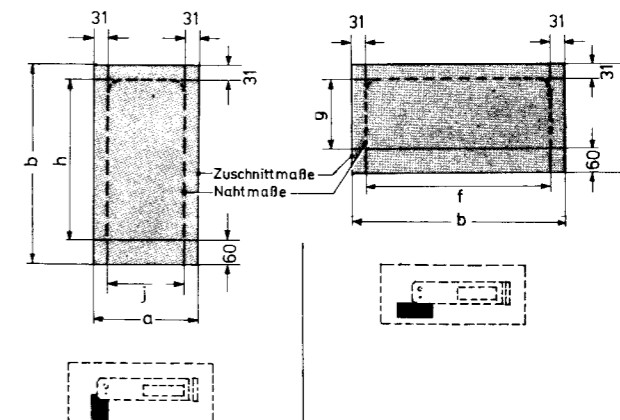

Lieferung des fertig montierten Nähguthalters

DELIVERY OF THE FINALLY ASSEMBLED WORKPIECE CLAMP

Patten	Kragen	Manschetten	großer Kragen
396 41 010 4	396 41 020 4	396 41 030 4	396 41 021 4

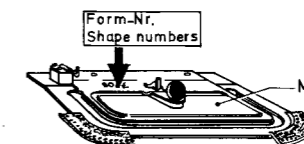

bei Nachbestellung bitte Form-Nr. angeben
bei Lieferung einer neuen Form bitte Muster oder
Schablone einschicken

PLEASE, STATE TYPE-No. IN CASE OF A SUPPLEMENTARY ORDER;
BY DELIVERY OF A NEW FORM OF CLAMP, PLEASE SEND PATTERN
OR TEMPLATE

Fertigung des Nähguthalters durch den Kunden.

MANUFACTURE OF WORKPIECE CLAMP BY CUSTOMER

verstellbarer Nähguthalter

WORKPIECE CLAMP ADJUSTABLE

Zuschnitt- maße(mm) a · b (mm)	Nahtmaße(mm)		A	B	C
	j · h max	f · g max			
250 · 600	188 · 509	538 · 159	396 41 015 2	---	396 41 014 2
Platten 1000 · 2000 *			699 81 830 6 *	---	699 99 152 8 *

* werden andere Maße ge-
wünscht, so ist dies bei der
Bestellung anzugeben.
PLEASE, STATE IN CASE OF AN ORDER
WHETHER OTHER DIMENSIONS ARE REQUIRED
OR NOT

Lieferung des fertig montierten Nähguthalters

DELIVERY OF THE FINALLY ASSEMBLED WORKPIECE CLAMP

- Manschetten
- großer Kragen
- 396 41 040 4
- 396 41 039 4
- 396 41 752 4
- A 396 41 015 2
250 · 600 mm
- C 396 41 014 2
250 · 600 mm

bei Nachbestellung bitte Form-Nr. angeben, -
bei Lieferung einer neuen Form bitte Muster oder
Schablone einschicken

PLEASE, STATE TYPE-No. IN CASE OF A SUPPLEMENTARY ORDER;
BY DELIVERY OF A NEW FORM OF CLAMP PLEASE, SEND PATTERN OR TEMPLATE

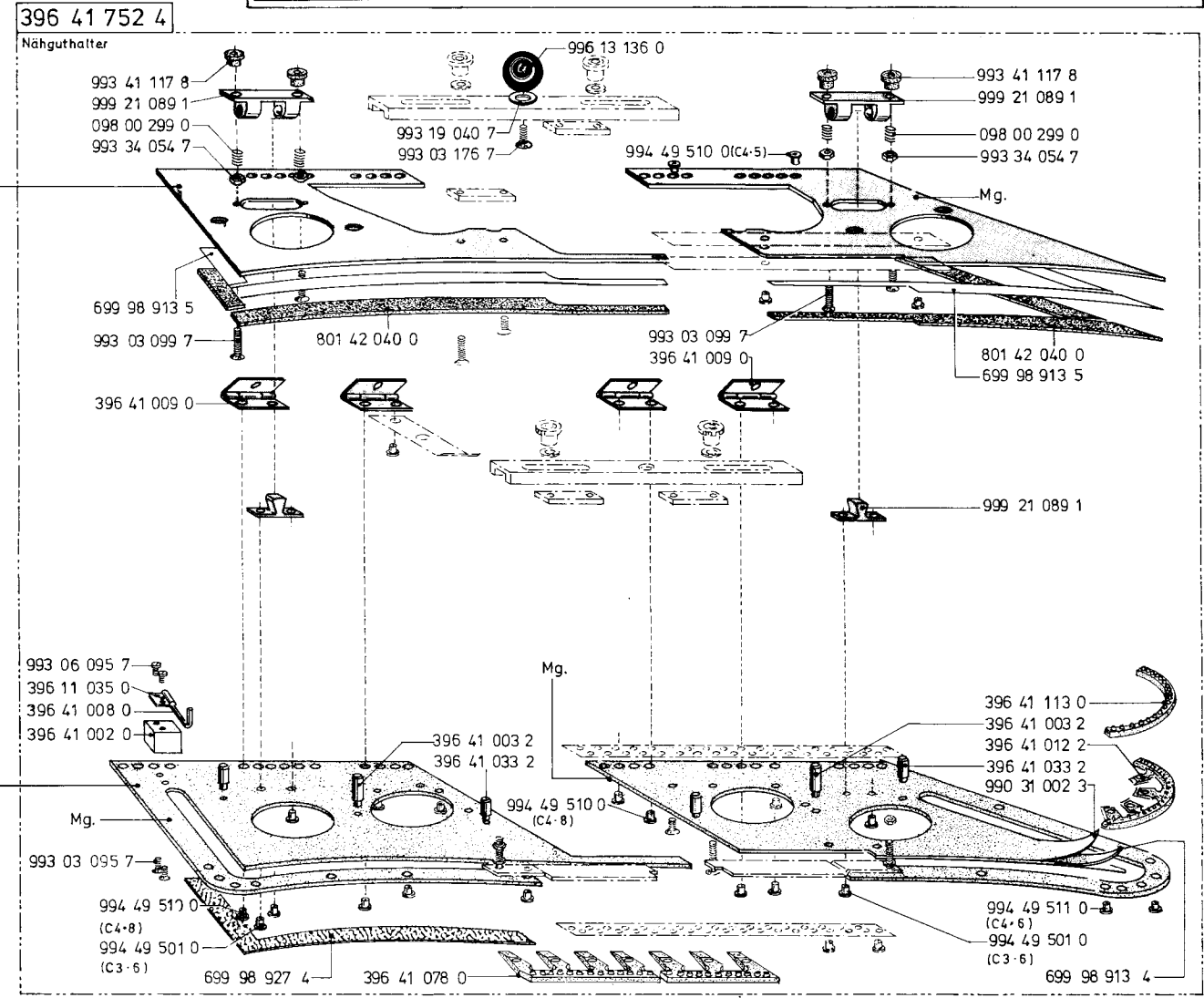
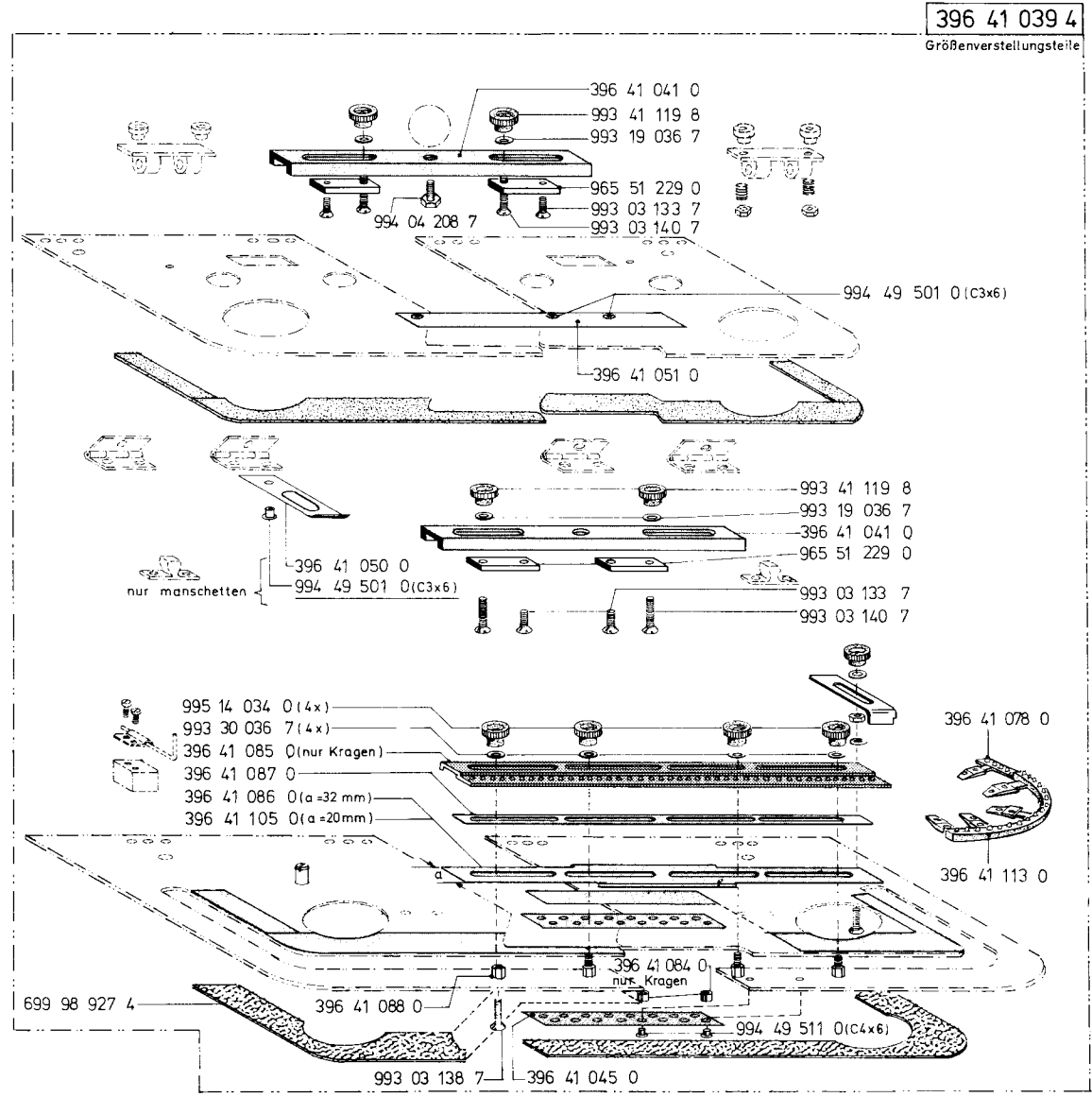
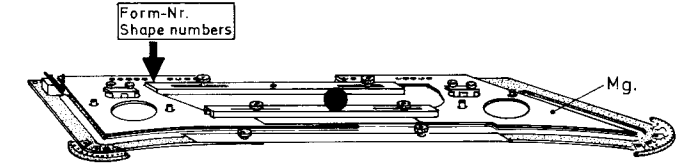

A
Al
15mm dick

C
Hartgewebe
3mm dick

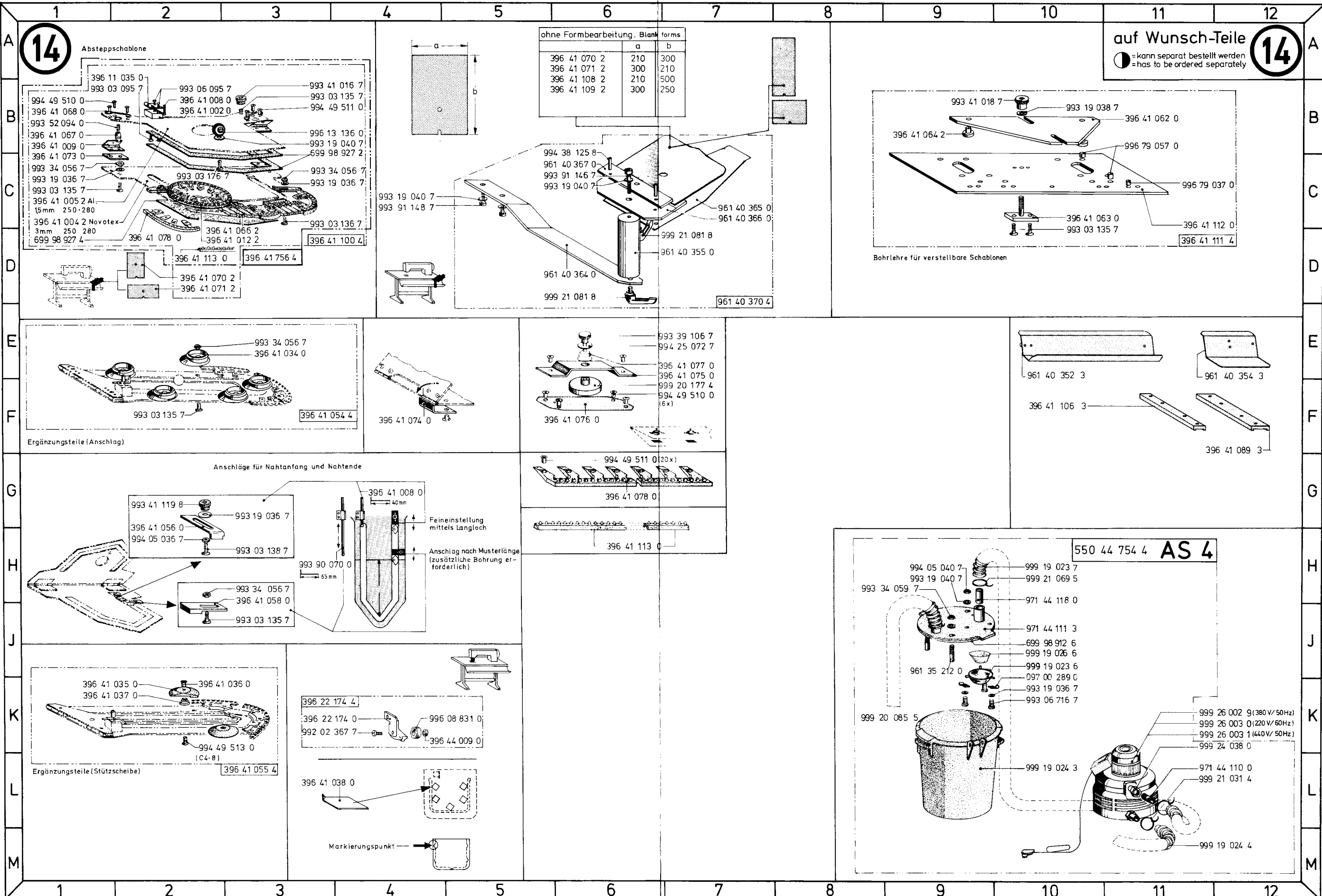

Teile-Nr.	Benennung	Bildtafel	Teile-Nr.	Benennung	Bildtafel	Teile-Nr.	Benennung	Bildtafel	Teile-Nr.	Benennung	Bildtafel
K016 00 331 0	SCHEIBE DISC	2F5	K098 00 299 0	DRUCKFEDER PRESSURE SPRING	12D3 13F7 13F11		NL76-1,5		K296 00 018 0	REGULIERSTUECK REGULAT PIECE	1L6
K026 15 226 0	SCHEIBE DISC	3C4	K100 01 030 0	OBERTEILAUFLAGE	4D4	K196 00 112 0	VERSCHL-STOPFEN	1D2 1H4 3A3 11A2 11B1	K296 00 033 0	OELDOCHT OIL WICK	1D2
K030 00 134 0	FEDER SPRING	2H9	K100 03 015 0	EINSATZ INSERT	4A5 4E4	K196 00 115 0	FADENANZUGFEDER TENSION SPRING	1C3	K296 00 034 0	BOLZEN BOLT	1D3
K030 00 175 0	SCHEIBE DISC	1M10	K100 03 030 4	SCHALTER SWITCH	11L8	K196 00 150 0	ABLASSSCHRAUBE DRAIN SCREW	2E5	K296 00 035 3	STELLRING	1D4
K037 00 022 0	HUELSE BUSH	11B1	K100 03 059 0	WINKEL ANGLE	4G7	K196 00 169 0	SCHEIBE DISC	2L5	K296 00 041 0	GLEITSTEIN SLIDE STONE	1F2 11D4
K053 00 025 0	SPANNUNGSFEDER TENSION SPRING	1C4	K104 00 225 0	ZUGFEDER SPRING	2J5	K196 00 170 0	ANSCHLAG GUIDE	2E4 3M7	K296 00 045 3	KURBEL CRANK	1E5
K053 00 035 0	SCHEIBE DISC	1K9 3B5	K142 30 002 0	MARWA-SENKER D16 X90GR	11M2	K196 00 186 0	BUCHSE BUSHING	2E6	K296 00 048 0	ANLAUFSCHEIBE DISC	1E4
K053 00 148 0	BLATTFEDER LEAF SPRING	2C5	K170 11 038 0	SPANNUNGSFEDER TENSION SPRING	1G3	K196 00 187 0	ROEHRCHEN PIPE	2K5	K296 00 049 3	GEGENGEWICHT COUNTERWEIGHT	11C6
K067 00 247 0	HAKEN HOOK	2F10	K170 13 006 3	KLOBEN BLOCK	1F1 11E1	K196 00 188 0	DICHTSCHEIBE GASKET	2L5	K296 00 050 0	DOCHT WICK	1D2 11C2
K067 00 906 0	DRUCKFEDER PRESSURE SPRING	3H7	K170 15 006 0	SCHEIBE DISC	1J7	K196 00 189 0	DRUCKFEDER PRESSURE SPRING	2F6	K296 00 051 0	SCHEIBE DISC	1D2 2K10
K067 23 305 0	DRUCKFEDER PRESSURE SPRING	2K8	K170 15 010 2	DISTANZRING	1K10	K196 00 198 3	STIRNRAD WHEEL	2L9	K296 00 071 0	OELSCHLAUCH OIL HOSE	1A6 11D9
K067 32 015 0	DRUCKFEDER PRESSURE SPRING	1G8	K170 16 006 0	HALTBLECH HOLDING PLATE	1K7	K196 00 199 3	STIRNRAD WHEEL	2L6	K296 00 075 0	HUELSE BUSH	11D6
K067 35 008 0	DRUCKFEDER PRESSURE SPRING	1L10	K170 16 009 0	GELENK JOINT	2H5	K196 00 283 0	BLATTFEDER LEAF SPRING	2E10	K296 00 101 0	OELDOCHT OIL WICK	1D5 11C5
K068 00 056 0	STOFFDR STANGE FOOT BAR	11C1	K170 16 012 3	SCHRAUBE SCREW	2G5	K196 00 285 0	ZAPPENSCHRAUBE SCREW	2E7	K296 00 114 0	RING RING	1B8 11D10
K068 00 183 0	FEDER SPRING	11E3	K170 16 013 0	EXZENTERBUCHSE ECCENTR BUSH	2H4	K196 00 294 0	FUEHRUNGSBUCHSE GUIDE BUSHING	2D11	K296 00 116 0	NIPPEL NIPPLE	1B7
K068 00 519 0	DRUCKFEDER PRESSURE SPRING	1G2	K171 25 004 0	OELFANGBLECH OIL DRIP SHEET	5D9	K199 00 272 3	KLOBEN BLOCK	5F9	K296 00 118 0	HOHLSCHRAUBE HOLLOW SCREW	1C7
K068 00 533 0	SCHEIBE DISC	3L5	K196 00 002 3	KOPFDECKEL HEAD COVER	11D5	K199 00 272 4	KNIEHEBEL KNEE LEVER	5F9	K296 00 120 0	SCHEIBE DISC	1D8
K069 12 002 0	STOPFEN PLUG	1H5	K196 00 006 0	HANDRAD HANDWHEEL	11B10	K199 00 274 0	STANGE ROD	5F9	K296 00 121 0	OELSCHLAUCH OIL HOSE	1C8
K077 11 022 0	AUFLAGE SUPPORT	5K9	K196 00 019 0	VERSCHL SCHRIB SCREW	1D2	K200 02 010 0	UNTERLEGSCHEIBE DISC	4G2	K296 00 130 0	OELROHR OIL PIPE	1C8
K077 11 023 0	ZENTRIERSTUECK CENTERING PIECE	5J11	K196 00 027 0	HUELSE BUSH	1D3	K220 00 296 0	ZUGFEDER SPRING	2F10	K296 00 131 3	OELSCHRAUBE OIL SCREW	1A8
K081 00 139 0	SCHEIBE DISC	2E7	K196 00 029 0	SPANNBUCHSE TENSION BUSHING	1C3	K296 00 003 0	ARMDECKEL ARM COVER	11D9	K296 00 131 4	OELSCHRAUBE OIL SCREW	1A8
K088 15 735 0	ZUGFEDER SPRING	1K2	K196 00 042 3	KLOBEN BLOCK	1E2	K296 00 004 0	ARMWELLE ARM SHAFT	11B7	K296 00 136 0	OELROHR OIL PIPE	1B8
K091 00 214 0	ZAHNRIEMEN BELT	1G9 2M12	K196 00 043 3	GELENK JOINT	1D2 11C4	K296 00 004 4	ARMWELLE ARM SHAFT	11B7	K296 00 144 0	NIPPEL NIPPLE	2K8
K096 14 195 3	STELLRING ADJ RING	2M9	K196 00 044 0	BUCHSE BUSHING	1F2 11D2	K296 00 007 0	GEHAEUSE HOUSING	1E5 11C6	K296 00 194 0	BUCHSE BUSHING	2L11
K096 15 241 3	SCHARNIER	2F2	K196 00 047 0	FEDER SPRING	1E2 11C2	K296 00 008 0	RING RING	1D6 1E9 11B6 11C8	K296 00 208 3	LAGER BEARING	1K9
K096 15 277 0	FEDER	2G2	K196 00 048 0	WINKEL ANGLE	11C5	K296 00 009 0	GEHAEUSE HOUSING	1E6 11B6	K296 00 209 0	ACHSE AXLE	1J9
K096 15 282 0	SPANNUNGSFEDER TENSION SPRING	2G2	K196 00 049 0	NADELLAGER NEEDLE BEARING	1E3 1E4 2H4 11C3	K296 00 012 0	GEHAEUSE HOUSING	1D9	K296 00 210 4	SPANNROLLE CLAMPING ROLLER	1J9
K097 00 289 0		14K10	K196 00 067 0	FEDER SPRING	1E1 11C1	K296 00 014 0	HUELSE BUSH	1E10 11C9	K296 00 211 3	ZAHNRIEMENRAD	2K12
K097 00 335 0	SCHRAUBE SCREW	1D4 11B3	K196 00 101 0	DICHTUNG GASKET	11D5						

Teile-Nr.	Benennung	Bildtafel	Teile-Nr.	Benennung	Bildtafel	Teile-Nr.	Benennung	Bildtafel	Teile-Nr.	Benennung	Bildtafel
K296 00 212 3	BELT PULLEY ZAHNRIEMENRAD	1E9	K296 16 054 0	BUCHSE BUSHING	2F3	K296 33 029 0	GUIDE BOLT FUEHRUNG	3D3	K396 10 054 0	HOLDING PLATE ANSCHLAG	1K7
K296 10 003 0	BELT PULLEY ARMWELLE	1C4 1E7	K296 16 056 3	KURBEL CRANK	2F7	K296 33 030 0	GUIDE OELDOCHT	3D3	K396 10 055 0	LAGERGEHAEUSE	1D10 11B9
K296 10 003 4	ARM SHAFT ARMWELLE	1D6	K296 16 057 3	KURBEL CRANK	2F9	K296 33 033 0	OIL WICK BUCHSE	3E3	K396 10 055 4	GEHAEUSE HOUSING	1D10 11B9
K296 10 011 3	ARM SHAFT STIFT	1C9 11B8	K296 16 062 0	BUCHSE BUSHING	2M9	K296 33 034 0	BUSHING OELFILZ	3F2	K396 10 061 0	ROHR PIPE	1H8
K296 10 012 0	PIN STUETZE	1D9 11B8	K296 16 067 0	BUCHSE BUSHING	3C6	K296 33 035 0	FILZHALTER FELT HOLDER	3G2	K396 10 062 0	ROHR PIPE	2D3
K296 13 011 0	SUPPORT FUEHRUNGSSTUECK	1F2 11E2	K296 16 071 0	LAGERBOCK PILLOW BLOCK	2G8	K296 33 036 0	MESSERHALTER KNIFE SUPPORT	3G2	K396 10 063 0	ROHR PIPE	1K9
K296 13 014 3	GUIDE PIECE WINKELHEBEL	1B1	K296 16 072 0	BOLZEN BOLT	2G7	K296 33 036 4	MESSERHALTER KNIFE SUPPORT	3G2	K396 10 066 3	KABEL CABLE	1H4
K296 13 016 0	LEVER SCHRAUBE	1A1 1A9	K296 16 079 0	GEWINDEBUCHSE THREADED BUSH	2J9	K296 34 019 0	WELLE SHAFT	2F11	K396 10 067 0	KOPFDECKEL HEAD COVER	1H2
K296 13 018 4	SCREW WINKELHEBEL	1B9 2B10	K296 16 084 0	EINSTELLHEBEL ADJUST LEVER	1L8	K296 34 019 4	WELLE SHAFT	2F4	K396 10 068 3	MAGNET	1J3
K296 13 020 3	LEVER DRUCKSTANGE	2B10	K296 16 087 0	BUCHSE BUSHING	1M10	K296 34 031 3	STELLRING ADJ RING	3J6	K396 10 069 0	MARKIERUNGSBAND MARKINGTAPE	1H10
K296 13 021 0	PRESSURE ROD LUEFTERHEBEL	2C10	K296 16 090 0	GELENKBOLZEN JOINT BOLT	1L8	K296 34 032 0	SCHETBE DISC	3H6 3J8	K396 10 083 0	LAGERBOCK PILLOW BLOCK	4F10
K296 13 022 3	LIFTER LEVER MITNEHMER	2D9	K296 16 093 0	KONTAKTHEBEL CONTACT LEVER	2H11	K296 34 035 0	WELLE SHAFT	3K8	K396 10 084 0	SAUGDUESE SUCTION JET	3B2
K296 13 023 0	CATCH FEDERBUEGEL	1M8	K296 16 094 0	DREHFEDER SPRING	2H10	K296 34 036 0	BUCHSE BUSHING	3G6 3K8	K396 10 085 4	KOPFDECKEL HEAD COVER	1L2
K296 14 001 0	SPRING BOW GRUNDOPLATTE	2C7	K296 16 097 0	ZYL STIFT CYLIND PIN	2J12	K296 35 029 0	BUCHSE BUSHING	3D8 3M10	K396 10 086 0	HALTER HOLDER	1H10 4E8
K296 14 003 0	BASE PLATE ANZEIGE	2B6	K296 16 112 0	BOLZEN BOLT	2F5	K367 17 008 3	SPULERRAD WINDER WHEEL	1H8	K396 10 086 4	HALTER HOLDER	4G8
K296 15 001 3	INDICATOR LAGER V	1J9	K296 25 001 0	HAUBE COVER	5F7	K381 11 004 3	RAENDELMUTTER KNURLED NUT	1D4	K396 10 087 0	RIEMENSCHUTZ BELT GUARD	1L11
K296 15 002 3	GREIFERWELLE HOOK SHAFT	2K6	K296 25 008 0	BUEGEL BOW	4C9	K396 10 003 0	DICHTUNG GASKET	1K2	K396 10 088 0	FINGERSCHUTZ FINGER GUARD	1H6
K296 15 004 0	BUCHSE BUSHING	2K6	K296 31 098 0	STOPFEN PLUG	1H4	K396 10 009 0	HALTER HOLDER	1H9	K396 10 089 0	OELFALLROHR	1A7
K296 15 282 0	SPULE BOBBIN	2H2 2L2 5C15	K296 33 003 3	HUBEXZENTER STROKECAM	1E7	K396 10 009 4	HALTER HOLDER	1H9	K396 10 089 4	OELFALLROHR	1A7
K296 16 012 0	STOPFEN PLUG	2F11 2G3 3B4	K296 33 003 4	HUBEXZENTER STROKECAM	1D7	K396 10 011 0	ARM ARM	1M7	K396 10 090 4	OBERTEIL KPL. 396 - DV	1M7 2E9
K296 16 015 3	STELLRING ADJ RING	2F3	K296 33 018 0	DISTANZBUCHSE DISTANCE BUSH	3E3	K396 10 016 3	ARMDECKEL ARM COVER	1G6	K396 10 091 3	VENTILGEHAEUSE VALVE CASE	1D6 11A5
K296 16 017 0	BUCHSE BUSHING	2F11	K296 33 020 0	KEGELMUTTER CONIC NUT	3D4 3E2 3E6	K396 10 016 4	ARMDECKEL ARM COVER	1G6	K396 10 091 4	VENTILGEHAEUSE VALVE CASE	1D6 11A5
K296 16 023 0	OELFANGBLECH OIL DRIP SHEET	2C3	K296 33 021 0	ZUGSTANGE PULL ROD	3E3	K396 10 020 3	RIEMENSCHUTZ BELT GUARD	1H11 5B12	K396 10 094 0	SCHRAUBE SCREW	1D5 11A4
K296 16 039 3	TRANSP STANGE FEED BAR	2F4	K296 33 024 0	OELROHR OIL PIPE	3C4	K396 10 021 0	RIEMENSCHUTZ BELT GUARD	5B12	K396 10 096 0	ANSATZBUCHSE	1J1
K296 16 043 3	TRAEGER CARRIER	2F5	K296 33 025 0	OELDOCHT OIL WICK	3C4	K396 10 021 0	RIEMENSCHUTZ BELT GUARD	5B12	K396 10 098 0	KLEMMSTUECK CLAMP PIECE	1H10
K296 16 049 0	WELLE SHAFT	2G7	K296 33 026 0	LAGERBOLZEN BEARING BOLT	3C5	K396 10 023 3	VERSCHL SCHEIBE DISC	1D10	K396 10 103 0	LEITBLECH GUIDE PLATE	1E2
K296 16 052 0	BUCHSE BUSHING	2F6	K296 33 026 4	LAGERBOLZEN BEARING BOLT	3C5	K396 10 048 3	VERSCHL SCHEIBE DISC	11D9	K396 10 117 0	SCHUTZGEHAEUSE	1E6 11C6
K296 16 053 0	OELFILZ OIL FELT	2F6	K296 33 028 0	FUEHRUNGSBOLZEN	3E2	K396 10 051 0	FADENHEB SCHUTZ PROTECTOR	1G6	K396 11 001 0	BOLZEN BOLT	1C2
						K396 10 053 0	HALTEBLECH	1H5	K396 11 003 4	FADENSANNUNG THREAD TENSION	1C2
									K396 11 026 0	SPANNBUCHSE	1F6 1K6

Teile-Nr.	Benennung	Bildtafel	Teile-Nr.	Benennung	Bildtafel	Teile-Nr.	Benennung	Bildtafel	Teile-Nr.	Benennung	Bildtafel
	TENSION BUSHING			TENSION DISC							
K396 11 031 0	BUCHSE BUSHING	1F5 1J6	K396 12 064 3	BUCHSE BUSHING	1F2	K396 14 079 0	ZUGFEDER SPRING	3L5	K396 16 006 0	EXZENTER ECCENTRIC	2F4
K396 11 032 0	FADENOESE THREAD LOOP	1F2	K396 13 001 3	KNIEPLATTE	5G10	K396 14 080 3	TRAEGERPLATTE CARRIER PLATE	3L7	K396 16 007 3	GELENK JOINT	2G5
K396 11 035 0	KLEMMSTUECK CLAMP PIECE	1J4 13K7 14A1	K396 13 011 0	DREHFEDER SPRING	2C9	K396 14 081 0	STUETZE SUPPORT	3K6	K396 16 017 4	KURBEL CRANK	2H9
K396 11 047 0	DRUCKFEDER PRESSURE SPRING	1E6 1K6	K396 13 012 0	STUETZE SUPPORT	2C10	K396 14 082 0	FUEHRUNGSWINKEL GUIDE ANGLE	3K5	K396 16 020 0	ZUGSTANGE PULL ROD	2G10 2H8
K396 11 053 0	MUTTER NUT	1B2	K396 13 027 0	SCHEIBE		K396 14 083 0	STOESSEL TAPPET	2C1	K396 16 022 3	EXZENTER ECCENTRIC	2M10
K396 11 057 3	SCHALTBUEGEL SWITCH BAR	1L3	K396 13 028 4	WINKELHEBEL LEVER	1B1	K396 14 088 0	BUNDBUCHSE	3L7	K396 16 023 0	DISTANZSCHEIBE DISTANCE DISC	2H9
K396 11 061 3	AUSLOESEHEBEL RELEASE LEVER	1C1	K396 13 030 0	LASCHE SHACKLE	1B1 11G1	K396 14 089 0	SPEZIALSCHRAUBE SPECIAL SCREW	3L7	K396 16 029 4	KURBEL CRANK	2H7
K396 11 063 0	ZUGLASCHE SHACKLE	1K3	K396 13 031 3	SCHALTHEBEL LEVER	11F1	K396 14 093 0	KEGELSTUMPFLEDE	3L7	K396 16 031 0	ZUGFEDER SPRING	2F7
K396 11 064 0	FUEHRUNGSROHR GUIDE TUBE	1L3	K396 13 035 0	STOFFDR STANGE FOOT BAR	1E1	K396 14 094 0	GLEITSTUECKHEBE	3L7	K396 16 033 0	ZUGFEDER SPRING	2H12
K396 11 065 0	AUSLOESESTIFT RELEASE PIN	1K3	K396 13 038 0	FUSSHALTER FOOT HOLDER	1G2	K396 15 001 0	SCHRAUBE SCREW	2F7	K396 16 034 3	WELLE SHAFT	2H10
K396 11 070 0	HALTEBLECH HOLDING PLATE	1H2	K396 13 041 3	SCHALTERTRAEGER SMITCH SUPPORT	1G2	K396 15 007 3	KAPPE CAP	2K5	K396 16 034 3	WELLE SHAFT	2H10
K396 11 071 0	FUEHRUNGSROHR GUIDE TUBE	1K2	K396 14 005 0	DICHTSCHEIBE GASKET	2A7	K396 15 008 0	SCHEIBE DISC	2K5	K396 16 035 3	STELLHEBEL LEVER	2G10
K396 11 073 3	SCHALTHEBEL LEVER	1K2	K396 14 009 3	ROHR PIPE	2C5	K396 15 016 0	ANTRIEBSWELLE DRIVING SHAFT	2M9	K396 16 036 0	BUCHSE BUSHING	2J10
K396 11 079 0	BUCHSE BUSHING	1K3	K396 14 040 0	SCHEIBE DISC	4D4	K396 15 018 0	HALTER HOLDER	2E4	K396 16 038 0	BUCHSE BUSHING	2M7
K396 11 092 3	FADENFUEHRUNG THREAD GUIDE	1J5	K396 14 042 0	SCHIEBER SLIDE	2B4	K396 15 018 3	HALTER HOLDER	2E4 2F4	K396 16 038 0	BUCHSE BUSHING	2M7
K396 11 105 0	ROLLENSTIFT ROLLER PIN	4A2	K396 14 043 3	GLEITSTUECK SLIDE PIECE	2B5	K396 15 033 0	DECKBLECH COVER PLATE	2K8	K396 16 039 4	TRANSP STANGE FEED BAR	2E4
K396 12 017 3	KURBEL CRANK	1E3	K396 14 045 0	WINKEL ANGLE	2C4	K396 15 037 4	EXZENTERRING ECCENTR RING	2M8	K396 16 045 3	KURBEL CRANK	2L7
K396 12 019 4	KURBEL CRANK	1E5	K396 14 047 0	GLEITSTUECK SLIDE PIECE	4D3	K396 15 038 0	GEW.-HUELSE	2E6	K396 16 055 3	STELLKLOBEN BLOCK	2G6
K396 12 024 0	FUEHRUNG GUIDE	1F3 11D5	K396 14 048 0	STOESSEL TAPPET	3K5	K396 15 067 3	DELROHR OIL PIPE	2K8	K396 16 058 0	LASCHE SHACKLE	2G9
K396 12 028 3	FADENHEBEL THREADLEVER	1E4	K396 14 049 0	GLEITSTUECK SLIDE PIECE	3L5	K396 15 068 4	VERTEILER	2K9	K396 16 059 0	GLEITBOLZEN SLIDE BOLT	2F8
K396 12 031 3	SCHRAUBE SCREW	11B2 11C2	K396 14 051 0	DICHTUNG GASKET	2B8	K396 15 079 0	FADENFUEHRUNG	2F2	K396 16 060 0	GLEITSTUECK SLIDE PIECE	2G9
K396 12 037 0	BUCHSE BUSHING	1E2	K396 14 052 0	DECKEL COVER	2B8	K396 15 080 0	ZYL.SCHRAUBE	2F2	K396 16 061 0	KLOBEN BLOCK	2F8
K396 12 039 0	BUCHSE BUSHING	1D2	K396 14 054 4	SCHIEBER SLIDE	2B4	K396 15 081 4	GREIFER	2H1 2L2	K396 16 067 0	GEWINDEBUCHSE THREADED BUSH	2G7
K396 12 060 3	NADELSTANGE NEEDLE BAR	1F2	K396 14 055 0	LASCHE SHACKLE	2C4	K396 15 082 4	SPULENGEHAEUSE BOBBIN CASE	2F1 2H2	K396 16 068 0	ANSCHLAG GUIDE	2G7
K396 12 060 4	NADELSTANGE NEEDLE BAR	1G2	K396 14 056 0	ZYLINDERTRAEGER	2B2	K396 15 084 0	GREIFERBLECH	2H1	K396 16 069 0	STELLHEBEL LEVER	2H8
K396 12 061 0	SPANNUNGSBOLZEN TENSION BOLT	1G3	K396 14 057 4	SCHIEBER SLIDE	2B2	K396 15 085 0	BREMSFEDER BRAKE SPRING	2G2	K396 16 075 0	FUEHRUNGSSTUECK GUIDE PIECE	2H8
K396 12 062 0	SPANNUNGSHUELSE TENSION BUSH	1G3	K396 14 059 0	GLEITSTUECK SLIDE PIECE	5D17	K396 15 086 0	SENKSCHEIBE SCREW	2F2	K396 16 076 0	STELLBOLZEN BOLT	2H9
K396 12 063 0	SPANNGS SCHEIBE	1G3	K396 14 069 4	AUSWERFER	3K7	K396 15 087 0	GEWINDESTIFT THREADED PIN	2G2	K396 16 077 0	KURVE CAM	2J9
			K396 14 073 0	ROLLE ROLLER	3K6	K396 15 088 0	STIFT	2H2	K396 16 078 3	STELLSCHEIBE ADJ DISC	2J9
						K396 16 002 0	FEDERBOLZEN SPRING BOLT	1M8			
						K396 16 003 0	BUCHSE BUSHING	1M10			
						K396 16 005 0	BUCHSE BUSHING	2G5			

Teile-Nr.	Benennung	Bildtafel	Teile-Nr.	Benennung	Bildtafel	Teile-Nr.	Benennung	Bildtafel	Teile-Nr.	Benennung	Bildtafel
K396 16 082 0	STICHEST HEBEL LEVER	1L8	K396 17 025 3	SPULERBOCK WINDER BLOCK	1G6		SPRING			BUSH	
K396 16 082 4	STICHEST HEBEL LEVER	1L8	K396 17 026 0	ARM	1G8	K396 33 099 0	BUCHSE BUSHING	3G3	K396 35 067 3	ZUGSTANGE PULL ROD	2M4
K396 16 085 0	GELENKBOLZEN JOINT BOLT	1L10	K396 17 027 0	KLOBEN BLOCK	1G6	K396 33 105 3	GEHAEUSE HOUSING	1D7	K396 35 068 3	STEUERKURVE CONTROL CAM	2M7
K396 16 086 0	STELLSCHRAUBE SCREW	1L10	K396 17 028 3	NOCKEN CAM	1H6	K396 33 159 3	BEF SCHRAUBE SCREW	3F6	K396 35 069 0	MESSER	2K3 5C15
K396 16 088 0	DACHPFUNG ABSORBER	1L9	K396 17 033 3	SPULERHELLE WINDER SHAFT	1F8	K396 33 160 0	OBERMESSER UPPER KNIFE	3G3 5C9	K396 35 072 0	LASCHE SHACKLE	2D2
K396 16 089 3	RAENDELKNOPF KNURLED KNOB	1L10	K396 20 039 3	STICHPLATTE	5E1	K396 33 161 0	WINKEL ANGLE	3C9	K396 35 074 0	DREHFEDER SPRING	2L5
K396 16 093 0	KURBEL CRANK	2J10	K396 20 044 3	STICHPLATTE	5F1	K396 33 161 4	WINKEL ANGLE	3B9	K396 35 075 0	GEGENMESSER COUNTERKNIFE	2M4 5C15
K396 16 093 4	KURBEL CRANK	2J10	K396 20 071 3	STICHPLATTE	5F1	K396 33 162 0	DISTANZSTUECK DISTANCE PIECE	3B8	K396 35 088 0	FUEHRUNGSBOLZEN GUIDE BOLT	2L5
K396 16 095 3	ARM ARM	3J12	K396 21 023 0	EINLAGE	5E1 5F3	K396 33 163 3	ZUGSTANGENKOPF ROD HEAD	3D8	K396 35 096 0	BOLZEN BOLT	2L3
K396 16 096 0	ANSCHLAG GUIDE	1M9	K396 21 024 0	TRANSPORTEUR	5E3 5F3	K396 33 164 0	GEHAEUSEDECKEL HOUSING COVER	3E6	K396 35 097 0	HUELSE BUSH	2L3
K396 16 100 3	STELLKURBEL	2F7 2J7	K396 22 145 4	ROLLFUSS	5B3 5E4 5F4	K396 33 166 0	NIEDERHALTER PUSH DOWN	3F4	K396 35 109 0	INSTALLATIONSPL	4K9
K396 16 101 0	GELENK JOINT	2J6	K396 22 162 0	ROLLFUSS	5B1	K396 34 022 0	KUPPLUNGSMELLE COUPLING SHAFT	3H9	K396 35 110 0	LAGERRING BEARING RING	2K4
K396 16 103 3	KURBEL CRANK	2H6	K396 22 162 4	ROLLFUSS	5E3 5F3	K396 34 100 0	KUPPLUNGSGEHAEUSE	3J7	K396 35 111 0	SEGMENT SEGMENT	2L4
K396 16 104 3	HALTER HOLDER	2K5	K396 22 163 0	FUEHRUNG	5B1	K396 34 162 3	TRANSPORTRAD FEED WHEEL	3J5	K396 35 113 0	GELENK JOINT	2K4
K396 16 105 3	HEBEL LEVER	2H4	K396 22 174 0	ROLLFUSS	14K3	K396 34 163 0	GELENKLASCHE KPL JOINT LINK CPL	3H10	K396 35 114 3	TRAGBLECH CARRIER PLATE	2M2
K396 16 106 0	EXZENTRIC ECCENTRIC	2J3	K396 22 174 4	ROLLFUSS	14K3	K396 34 164 0	TRANSP.HEBEL	3J10	K396 35 119 0	STOESSEL TAPPET	4A9
K396 16 108 0	STOPFEN PLUG	1L10	K396 25 001 3	HAKENSCHRAUBE HOOK SCREW	5C10	K396 34 165 4	KURBEL KPL CRANK CPL	3K9	K396 35 122 4	WARTUNGSEINHEIT CONDITION UNIT	4M6
K396 16 130 0	LAGERRING BEARING RING	2J7	K396 25 002 3	SCHARNIER HINGE	2C5	K396 34 166 0	LAGERBOCK PILLOW BLOCK	3G5 3K8	K396 35 125 3	SCHALTHEBEL LEVER	3G7
K396 16 141 0	BUCHSE BUSHING	2H5	K396 31 016 0	BUCHSE BUSHING	1F1 1D1	K396 34 168 0	STUETZSCHEIBE SUPPORT DISC	3J7	K396 35 129 3	SCHALTERTRAEGER SWITCH SUPPORT	1L4
K396 16 142 0	WELLE SHAFT	2H4	K396 31 017 0	SCHRAUBE SCREW	1D1	K396 34 170 4	KUPPL GEHAEUSE HOUSING	3J7	K396 35 131 0	GEHAEUSE HOUSING	4K12
K396 17 006 0	HUELSE BUSH	1H6	K396 31 026 0	DRUCKFEDER PRESSURE SPRING	1D2	K396 34 171 0	WELLE SHAFT	3H5	K396 35 132 0	KLEMMSCHEIBE CLAMPING DISC	1E11
K396 17 008 0	DRUCKFEDER PRESSURE SPRING	1G6	K396 33 011 3	GELENKSTUECK JOINT PIECE	3C6	K396 34 181 0	LEISTE REGLET	3H5 3K8	K396 35 133 0	WINKEL ANGLE	1E10
K396 17 011 3	AUSLÖSEHEBEL RELEASE LEVER	1F8	K396 33 012 0	FEDERHAKEN	3D6	K396 34 186 0	DRUCKFEDER PRESSURE SPRING	3G7	K396 35 133 4	WINKEL ANGLE	1F10
K396 17 014 0	KLEMMFEDER CLAMPING SPRING	1F8	K396 33 014 0	GEHAEUSE HOUSING	3C5	K396 34 232 0	FUEHRUNGSSTUECK GUIDE PIECE	1L5	K396 35 134 0	INSTALL.GEHAEUS	4F10
K396 17 015 4	SPANNUNG TENSTION	1F6 1K6	K396 33 014 4	GEHAEUSE HOUSING	3C5	K396 34 233 3	WINKEL ANGLE	1L5	K396 35 136 0	TRAEGER CARRIER	3G7
K396 17 016 0	FADENFUEHRUNG THREAD GUIDE	1F6 1J6	K396 33 015 0	DOPPELHEBEL LEVER DOUBLE	3D4	K396 35 009 0	STOESSEL TAPPET	4B10	K396 35 141 0	WINKEL	1M4
K396 17 017 0	GEWINDEBOLZEN THREADED BOLT	1F6 1J6	K396 33 016 0	GLEITSTUECK SLIDE PIECE	3D4	K396 35 060 3	LAGERPLATTE BEARING PLATE	2K4	K396 41 001 2	ZAHNSCHEIBE TOOTHED WASHER	12J4
K396 17 022 0	BUCHSE BUSHING	1F8	K396 33 063 0	SCHLEIBE DISC	3D7	K396 35 060 4	LAGERPLATTE	2K2	K396 41 002 0	ANSCHLAG GUIDE	12K1 13K7 14B2
			K396 33 064 0	MUTTER NUT	3C7 3E8	K396 35 060 4	LAGERPLATTE	2K2	K396 41 003 2	ANSCHLAGSTIFT PIN	12J1 13K9 13K11
			K396 33 065 0	GELENKLASCHE	3D7 3D8	K396 35 066 0	HUELSE	2L5	K396 41 004 2	PLATTE	12C6 12C9 12E8
			K396 33 066 0	DISTANZBUCHSE DISTANCE BUSH	3D5						
			K396 33 071 4	DOPPELHEBEL LEVER DOUBLE	3E4						
			K396 33 080 0	ZUGFEDER	3C7 3D9						

Teile-Nr.	Benennung	Bildtafel	Teile-Nr.	Benennung	Bildtafel	Teile-Nr.	Benennung	Bildtafel	Teile-Nr.	Benennung	Bildtafel
	PLATE	14C1		CLOTH HOLDER			NUT			BUSHING	
K396 41 005 2	PLATTE	12C6 12C9 12E7	K396 41 041 0	SCHIENE	13E4 13H5	K396 41 089 3	BOHRLEHRE	14F12	K396 44 012 0	SAEGELBLATT	11L1
	PLATE	14C1		RAIL		K396 41 100 4	NAEHGUTHALTER	14D4	K396 44 013 0	RIEMENSCHUTZ	11D10
K396 41 006 2	PLATTE	12C6 12E7	K396 41 045 0	BLECH	13M3		CLOTH HOLDER			BELT GUARD	
	PLATE			PLATE		K396 41 105 0	FUEHRUNGSSTUECK	13K2	K396 44 014 0	PLATTE	11J4
K396 41 008 0	SCHALTBUEGEL	12K1 13K7 14B2	K396 41 050 0	KLEMMFEDER	13J2		GUIDE PIECE			PLATE	
	SWITCH BAR	14G4		CLAMPING SPRING		K396 41 106 3	BOHRLEHRE	14F10	K430 27 736 0	SCHIEBE	1H8
K396 41 009 0	SCHARNIER	12H2 13G10 13H7	K396 41 051 0	ABDECKBLECH	13G4	K396 41 108 2	BLECH	14A6		DISC	
	HINGE	14B1		COVER PLATE			PLATE		K467 11 022 0	SPANNSCHEIBE	1C2
K396 41 010 4	SCHABLONE, KPL.	12K10	K396 41 054 4	ERGAENZUNGSSATZ	14F4	K396 41 109 2	BLECH	14B6		TENSION WASHER	
K396 41 011 4	KLEINT. F. NAENHGH.	12D4	K396 41 055 4	ERGAENZUNGSSATZ	14L3		PLATE		K550 44 754 4	ABSAUGANLAGE	14H11
K396 41 012 2	ZAHNSCHIEBE	13K12 14D3	K396 41 056 0	ANSCHLAG	14G2	K396 41 111 4	BOHRLEHRE	14D11	K550 44 754 9	ABSAUGAGGR KPL	14H10
	TOOTHED WASHER			GUIDE			BORE GAUGE			SUCTIONUNIT CPL	
K396 41 014 2	PLATTE	12C7 12F8 13B7	K396 41 057 0	ANSCHLAG	12H1	K396 41 112 0	PLATTE	14C11		AS4	
	PLATE	13E8		GUIDE			PLATE		K568 10 008 4	HANDRAD	1D12
K396 41 015 2	PLATTE	12C7 12F7 13B6	K396 41 058 0	ANSCHLAG	14H3	K396 41 113 0	ZAHNLEISTE	13K11 13L5 14D2		HANDWHEEL	
	PLATE	13D8		GUIDE			TOOTH BLADE	14H6	K568 14 014 0	OELROHR	2C6
K396 41 016 2	PLATTE	12C7 12F7	K396 41 062 0	AUFNAHMEPLATTE	14B11	K396 41 116 0	ANSCHLAG			OIL PIPE	
	PLATE			RECEPTION PLATE			GUIDE		K568 14 042 0	OELSTAB	2C7
K396 41 017 2	PLATTE	12C8 12F8	K396 41 063 0	ARRETIERTSTUECK	14C10	K396 41 751 4	SCHABLONE	12B5		OIL DIPSTICK	
	PLATE			CLAMP			TEMPLATE		K568 14 043 0	FILZSCHEIBE	2L11
K396 41 018 2	PLATTE	12C8 12F7	K396 41 064 2	BOLZEN	14B9	K396 41 752 4	SCHABLONE	12B6 13C8 13E7		FELT DISC	
	PLATE			BOLT			TEMPLATE		K568 15 018 0	EXZENTERRING	2L8
K396 41 019 2	PLATTE	12C8 12F7	K396 41 066 2	ANSCHLAGLEISTE	14D3	K396 41 753 4	SCHABLONE	12B7		ECCENTR RING	
	PLATE			GUIDE LEDGE			TEMPLATE		K568 15 019 3	EXZENTER	2L8
K396 41 020 4	SCHABLONE	12K10	K396 41 067 0	HUELSE	14B1	K396 41 754 4	NAEHGUTHALTER	12B8		ECCENTRIC	
	TEMPLATE			BUSH			CLOTH HOLDER		K568 15 020 0	KLOBEN	2L8
K396 41 021 4	NAEHGUTHALTER	12K12	K396 41 068 0	KLAMMER	14B1	K396 41 756 4	NAEHGUTHALTER	12B9 14D3		BLOCK	
	CLOTH HOLDER			CLAMP			CLOTH HOLDER		K699 81 830 1	AL. BLECH	12F7 13C7
K396 41 024 2	PLATTE	12C7 12F8	K396 41 070 2	BLECH	14A6 14D2	K396 44 001 0	KLOBEN	11F3		2,5 LWX1	
	PLATE			PLATE			BLOCK		K699 81 830 6	AL. BLECH	12F7 13C6
K396 41 025 2	PLATTE	12C7 12F7	K396 41 071 2	BLECH	14A6 14D2	K396 44 001 4	KLOBEN	11F4		2,5 LWX1	
	PLATE			PLATE			BLOCK		K699 97 910 0	SCHLAUCH	1J4 2C8 2K8
K396 41 026 2	PLATTE	12C7 12F7	K396 41 072 0	BUCHSE	3K7	K396 44 002 0	SCHUBSTANGE	11D2		6X19X4M	2K9 2K11
	PLATE			BUSHING			CONNECTING ROD		K699 97 911 1	SCHLAUCH	4F6 11L10
K396 41 028 0	MUTTER	12F3	K396 41 073 0	LASCHE	14C1	K396 44 003 0	PISTON	11E3		SCHLAUCH	2C1 2D1 4C9 4D9
	NUT			SHACKLE			PISTON		K699 98 912 6	KLEBEBAND	12J3 14J10
K396 41 029 0	DREHFEDER	12F2	K396 41 074 0	WINKEL	14F4	K396 44 004 0	LEHRE	11L3		KLEBEBAND	12K4 13M12
	SPRING			BUEGEL	14E7		GAUGE		K699 98 913 5	KLEBEBAND	12K3 13G7 12G11
K396 41 030 4	SCHABLONE, KPL.	12K11	K396 41 076 0	HALTEBLECH	14F6	K396 44 005 0	SPANNSTUECK	11F4		STREIFEN AGL.	14B4
K396 41 031 0	GEWINDEHUELSE	12K2	K396 41 077 0	KEGELSTUMPFEDER	14E7		TENSION PIECE		K699 98 927 2	STREIFEN AGL.	13M1
	THREADED BUSH		K396 41 078 0	ZAHNSTANGE	13K5 13M9 14D2	K396 44 006 0	PLATTE	11H3		25X18M	
K396 41 033 2	ANSCHLAGSTIFT	12J1 13K9 13K12		ROD	14G6		PLATE		K699 99 152 8	HARTGEWEBE	12F8
	PIN			PLATTE	12F8	K396 44 006 4	SCHNITTPLATTE	11H3		DOCHT RD.1,5	2F3 3D4
K396 41 034 0	ANSCHLAG	14E3	K396 41 081 2	PLATTE	12F7		CUTTING PLATE		K699 99 158 2	DOCHT RD.3	1B8
	GUIDE			PLATTE	12F7	K396 44 007 0	EINLAGE	11H3		DOCHT RD.3	2F5 3D5
K396 41 035 0	STUETZSCHEIBE	12K1 14K1	K396 41 084 0	BUCHSE	13L4		LAYER		K699 99 158 5	DOCHT	1H5
	SUPPORT DISC			BUSHING		K396 44 008 0	ROLLENFUSS	11G1		DOCHT RD.5	2F3 3B4
K396 41 036 0	BUCHSE	14K3	K396 41 085 0	SCHIENE	13K2		ROLLER FOOT		K801 42 040 0	GUMMIMATTE	13G8 13G11
	BUSHING			RAIL		K396 44 008 4	ROLLENFUSS	11G1		RUBBER MAT	
K396 41 037 0	DREHFEDER	14K1		PA 30% GKV			ROLLER FOOT		K802 51 097 0	SCHIEBE	3G5
	SPRING		K396 41 086 0	FUEHRGS STUECK	13K2	K396 44 009 0	BOLZEN	5B1 5B3 11H1		DISC	
K396 41 038 0	MARKIERUNGSBLECH	14L3		GUIDE SECTION			BOLT	14K4	K802 51 285 3	KLEMMKLOBEN	11D6
K396 41 039 4	VERST EINRICHTG	13C8 13E5	K396 41 087 0	LEISTE	13K2		BUCHSE	11A2		BLOCK	
	REGULAT DEVICE			REGLET		K396 44 010 0	BUCHSE		K893 06 652 0	SCHRAUBE	2E10
K396 41 040 4	NAEHGUTHALTER	13C8	K396 41 088 0	MUTTER	13M2		BUCHSE	11D2 11F3		SCREW	

Teile-Nr.	Benennung	Bildtafel	Teile-Nr.	Benennung	Bildtafel	Teile-Nr.	Benennung	Bildtafel	Teile-Nr.	Benennung	Bildtafel
K893 06 714 7	M2,6X4 SCHRAUBE SCREW	2L2	K894 62 192 7	SCHRAUBE SCREW		K961 40 367 0	LEISTE REGLET	14C6	K980 40 319 3	OELTOPF KPL OIL POT CPL	11E9
K893 06 716 7	M4X6 SCHRAUBE SCREW	1M9 2M2	K894 62 206 7	6KT, BLECHSCHR. BB, 0X32, 0	4H1 4J3	K961 40 370 4	HALTER HOLDER	14E7	K980 40 320 0	OELROHR OIL PIPE	11D9
K893 06 734 7	M4X10 SCHRAUBE SCREW	2G4	K895 36 101 0	ZYL STIFT CYLIND PIN	11F2	K961 40 432 0	PLATTE PLATE	4G4	K980 40 321 0	DOCHT WICK	11D9
K893 06 820 7	M5X 6 SCHRAUBE SCREW	2K3	K895 36 163 0	ZYL STIFT CYLIND PIN	2H6	K961 48 108 4	PLATINE PLATE	4M9	K980 40 322 0	OELSCHLAUCH OIL HOSE	11D8
K893 21 106 8	FEDERRING SPRING RING	11J11	K907 01 001 0	OBERTEILAUFLAGE DRAWER	4D4	K961 48 120 4	VERTEILER DISTRIBUTOR	4F11	K980 44 033 0	ZUGFEDER SPRING	3M5
K893 21 109 8	FEDERRING SPRING RING	4H3 4J3 4K2 4L2 4L3	K907 02 008 3	SCHUBKASTEN GUIDE BAR	4F1	K961 48 124 4	INSTALLATION 23 23	4M10	K990 12 007 6	KEILRIEMEN V BELT	11D11
K893 21 110 8	FEDERRING SPRING RING	4H4 4J1 4K4	K907 02 009 0	FUEHRUNGSLEISTE GUIDE BAR	4E1	K965 51 229 0	PLATTE PLATE	13F4 13J5	K990 12 011 3	KEILRIEMEN V BELT	4A8
K893 23 043 8	FEDERSCHEIBE SPRING DISC	4J10	K907 03 049 4	BEF TEILE FASTENING PARTS	4J8	K970 40 245 0	DISTANZBOLZEN BOLT	11H11	K990 12 013 1	KEILRIEMEN 10X1133	1C11
K893 23 047 7	FEDERSCHEIBE SPRING DISC	4C4	K917 01 009 3	TISCHPLATTE TABLE TOP	4E4	K971 40 155 0	MOTORWIPPE MOTORWIPPE	11J12	K990 13 000 1	RUNDRIEMEN ROUND BELT	3D5
K893 23 049 8	FEDERSCHEIBE SPRING DISC	2J9	K917 01 011 3	TISCHPLATTE TABLE TOP	4E4	K971 40 156 0	GEWINDEBUCHSE BUSHING	11H12	K990 23 040 9	STECCKER PLUG	4F7 11L11
K893 33 092 0	GEWINDESTIFT THREADED PIN	3H5	K917 03 018 4	SCHUTZSCHALTER SWITCH	4E6	K971 44 007 0	BUCHSE BUSHING	11B2	K990 24 005 7	MUFFE 16A 5POL	5J11
K893 52 094 0	GEWINDESTIFT THREADED PIN	12K2	K931 31 903 0	ZUGFEDER SPRING	1C1	K971 44 040 3	GEGENGEWICHT COUNTERWEIGHT	11C7	K990 24 016 0	VERSCHL STOPFEN PLUG	11H12
K893 96 143 0	FL.KOPFSCHR. M4X18	1E5 11C6	K961 35 212 0	BOLZEN BOLT	14J9	K971 44 041 0	SCHEIBE DISC	11B3	K990 25 417 5	NETZTEIL MAINS UNIT	4C6
K894 04 825 0	SCHRAUBE SCREW	2F4	K961 40 351 0	TRAEGER CARRIER	4F1	K971 44 110 0	ROHRNIPPEL PIPE	14K12	K990 25 418 4	MOTOR 18.035.006	4E8
K894 44 094 8	ZAHNSCHEIBE TOOTHED WASHER	1J3	K961 40 352 3	SCHABLONENAUFLL. ANSATZNIE	14E10	K971 44 111 3	ABDECKPLATTE COVER PLATE	14J10	K990 25 417 7	POSITIONSGEBER SYNCHRONIZER	4E8
K894 45 036 8	FAECHERSCHEIBE DISC	2G8 2G10 2H10 2M4 4F2 4G3	K961 40 353 2	ANSAZLNIE	14F12	K971 44 118 0	ROHR PIPE	14H10	K990 25 418 4	MOTOR 220/380V	4A5
K894 45 037 8	FAECHERSCHEIBE DISC	2C10	K961 40 354 3	ABLAGE	14F12	K971 44 118 0	ROHR PIPE	14H10	K990 25 418 6	MOTOR 220/415V	4A5
K894 45 040 8	FAECHERSCHEIBE DISC	1L10	K961 40 355 0	STUETZE SUPPORT	4D1 14D7	K977 40 125 0	LASCHE SHACKLE	4J2	K990 25 419 6	STEUERPLATTE CONTR PANEL	4C6
K894 45 066 8	FAECHERSCHEIBE DISC	3C6	K961 40 356 0	AUFLAGE SUPPORT	4D1	K980 40 106 0	STENBOLZEN BOLT	11J7	K990 25 419 8	SOLLWERTGEBER 18.045.609	4C5
			K961 40 357 0	HALTER HOLDER	4D3	K980 40 108 3	RIEMENSCHLEIBE PULLEY	11E9	K993 25 153 1	MOTOR 60 Hz	11E11
			K961 40 358 0	ROHR PIPE	4C4	K980 40 150 0	OBERARM PIPE	11F7	K993 25 153 3	MOTOR 50 Hz	11E11
			K961 40 359 3	AUFLAGE SUPPORT	4F1	K980 40 150 4	OBERTAIL KPL. OBERTEIL KPL.	11F7	K990 29 153 5	MOTOR 60 Hz	11E11
			K961 40 361 3	SCHARNIER HINGE	4F1	K980 40 151 0	UNTERARM CRANK	11H7	K990 29 153 7	MOTOR 50 Hz	11E11
			K961 40 362 0	STUETZHEBEL SUPPORT LEVER	4G2	K980 40 159 3	KLOBEN BLOCK	11D2	K990 31 002 3	SCHLEIFPAPIER, 4 400C 280X230	12L3 13K12
			K961 40 363 3	ABLAGE REST	4C3	K980 40 160 3	KURBEL CRANK	11B3			
			K961 40 364 0	TRAEGER CARRIER	14D6	K980 40 160 4	KURBEL CRANK	11B3			
			K961 40 365 0	FUEHRUNGSPLATTE GUIDE PLATE	14C7	K980 40 161 0	BOLZEN BOLT	11B3			
			K961 40 366 0	SPANNPLATTE CLAMPING PLATE	14C7	K980 40 192 0	SCHEIBE DISC	3F2 11E5			
							VULCOLLAN				

Teile-Nr.	Benennung	Bildtafel	Teile-Nr.	Benennung	Bildtafel	Teile-Nr.	Benennung	Bildtafel	Teile-Nr.	Benennung	Bildtafel
K990 49 012 8	PINZETTE TWEEZERS GEBOGEN 3884-M/150	5D8	K992 00 347 0	SCHRAUBE SCREW NR86X5X1	3G2	K992 01 374 0	GEWINDESTIFT THREADED PIN NR.89X 3,3	2F3 2G4 3D5	K992 02 367 7	SCHRAUBE SCREW M4X4,3	5B1 5B3 14K3
K990 80 020 3	FILZSCHREIBER EDDING400	11L2	K992 00 399 0	GEWINDESTIFT THREADED PIN NR.28X 6	1E1 11E1	K992 01 383 7	MUTTER NUT NR.89	1H10 4F8	K992 02 411 0	SCHRAUBE SCREW M10X65	11J7
K990 80 024 3	FLACHBEUTEL,0,0 0,05X120X200	11M3	K992 00 422 0	GEWINDESTIFT THREADED PIN NR.28X 13	1E12	K992 01 386 0	LI.ZYL.SCHR. NR.89X10	3F2	K992 02 419 8	ZAPFENSCHR. NR.28X10	2E4
K990 81 003 8	KASTEN BOX	5G7	K992 00 427 7	SCHRAUBE SCREW NR.42X4,	11D9	K992 01 432 0	ROLLE ROLLER	4G2	K992 12 344 0	ZYL STIFT CYLIND PIN 1,80X27	1B3
K990 81 006 1	SCHRAUBENDREHER SCREWDRIVER A 0,4X 2,5	5C7	K992 00 431 7	SCHRAUBE SCREW NR.32X12	11E4	K992 01 491 0	GEWINDESTIFT THREADED PIN NR.40X 2,8	1A8	K993 02 016 0	ZYL STIFT CYLIND PIN 1,2M6X12	2K5
K990 81 006 2	SCHRAUBENDREHER SCREWDRIVER A 0,8X 5,5	5C7	K992 00 433 7	SCHRAUBE SCREW NR.40X5	2L5	K992 01 497 0	GEWINDESTIFT THREADED PIN NR28X15X21	1D12 11C11	K993 02 143 0	ZYL STIFT CYLIND PIN 6 M6X32	1D1
K990 81 006 7	HYDR.OEL,250GR. 250GR.E.NUTO H68	5B7	K992 00 665 0	GEWINDESTIFT THREADED PIN NR.40X 5,	1C2	K992 01 506 0	SENKSCHRAUBE SCREW NR.82X 2,5	2H1	K993 02 627 0	ZYL STIFT CYLIND PIN 5 H8X50	3C9
K990 81 010 1	NAEHM OEL 250GR OIL 250 GRAMS 250GR.E.SP-NK10	5B7	K992 00 674 6	SENKSCHRAUBE SCREW NR.54X5	1J4	K992 01 508 7	SCHRAUBE SCREW NR15X2,5X3	1B2 11F2	K993 03 094 7	SENKSCHRAUBE SCREW M3X6	12F2
K992 00 016 7	SCHRAUBE SCREW NR.28X13	2H8	K992 00 720 0	GEWINDESTIFT THREADED PIN NR.14X 4,5	1K6 2L6	K992 01 510 0	SENKSCHRAUBE SCREW NR.13	2F1	K993 03 095 7	SENKSCHRAUBE SCREW M3X8	12L2 13L7 14B2
K992 00 032 7	SENKSCHRAUBE SCREW NR.40X10	1H6	K992 00 742 7	MUTTER NUT NR.18 2,5	2G7	K992 01 511 0	GEWINDESTIFT THREADED PIN NR.18X 6,5	2G7 2M10	K993 03 099 7	SENKSCHRAUBE SCREW M3X18	1J2 12E3 13G7 13G10
K992 00 093 0	SCHRAUBE SCREW NR.32X8	1G6	K992 00 743 7	SCHRAUBE SCREW NR89X17X2	1J10 4F8	K992 01 727 7	MUTTER NUT NR.40	1H5	K993 03 100 7	SENKSCHRAUBE SCREW M3X20	1J2
K992 00 104 0	ZYL STIFT CYLIND PIN 2,70X10,7	1D6 11B5	K992 00 859 0	LI.ZYL.SCHR. NR.86X3	1D9 11B3	K992 01 758 0	SCHRAUBE SCREW NR.99X10,0	1E5	K993 03 133 7	SENKSCHRAUBE SCREW M4X5	13F4 13J5
K992 00 106 0	ZYL.SCHRAUBE	2G2	K992 00 981 0	FL.KOPFSCHR. NR.88X6,2	2D3	K992 01 791 0	SCHRAUBE SCREW NR.15	2D3	K993 03 134 7	SENKSCHRAUBE SCREW M4X6	3M5
K992 00 188 0	SCHRAUBE SCREW NR.42X5	2E4	K992 00 992 0	SCHRAUBE SCREW NR.13	2F2	K992 01 944 0	SCHRAUBE SCREW NR.23X9,3	1D9 1E9 2L12	K993 03 135 7	SENKSCHRAUBE SCREW M4X8	4F2 4F4 12H1 14B3 14C1 14C10
K992 00 209 0	GEWINDESTIFT THREADED PIN NR.28X 16	2E8 11B11	K992 00 993 0	SENKSCHRAUBE SCREW NR.47X2	2G2	K992 01 967 0	LINSENSCHRAUBE SCREW NR.40X 4,0	3D4	K993 03 136 7	SENKSCHRAUBE SCREW M4X10	14F2 14J3 11F9 14C3
K992 00 216 0	GEWINDESTIFT THREADED PIN NR.28X 9,5	1D3 2D3 11C7	K992 00 996 6	SENKSCHRAUBE SCREW NR89X 4X8,	2A4	K992 01 983 0	MUTTER NUT M4	2H8	K993 03 137 7	SENKSCHRAUBE SCREW M4X12	3L5 3L7 3M5
K992 00 228 0	ZAPFENSCHRAUBE SCREW NR.40X 7,	1F1	K992 01 187 7	SCHRAUBE SCREW NR.28X9	2E4	K992 01 985 6	SCHRAUBE SCREW M4	2K10	K993 03 138 7	SENKSCHRAUBE SCREW M4X16	13M3 14H3
K992 00 243 0	GEWINDESTIFT NR. 28X6	2D4	K992 01 243 0	GEWINDESTIFT THREADED PIN NR.18X 7,5	1E7 1F5 1K9 2L9	K992 01 998 0	SCHRAUBE SCREW	2H1	K993 03 140 7	SENKSCHRAUBE SCREW M4X20	12L3 13F4 13J5
K992 00 244 0	GEWINDESTIFT THREADED PIN NR.28X4	2M9	K992 01 265 7	SCHRAUBE SCREW NR.28X6,5	2B7	K992 02 298 0	SCHRAUBE SCREW NR.15X2,5	1A2	K993 03 168 7	SENKSCHRAUBE SCREW M5X50	3B2 4F10
K992 00 281 7	SCHRAUBE SCREW NR.88X6,	1E2	K992 01 353 0	ZYL.SCHRAUBE	2F1	K992 02 330 0	STIFT PIN	2B11			
K992 00 290 7	SCHRAUBE SCREW NR.32X9,	11G5									

Teile-Nr.	Benennung	Bildtafel	Teile-Nr.	Benennung	Bildtafel	Teile-Nr.	Benennung	Bildtafel	Teile-Nr.	Benennung	Bildtafel
K999 20 243 7	GEW.STIFT	2C6		G7X11X2		K999 24 039 1	VERSCHRAUBUNG	1K4 2C1 3D9 3K7		PA 6, GF30	
K999 21 004 8	EINSATZ INSERT 104CKX6	11H2 11H5	K999 23 021 8	DICHTRING GASKET RING G10X14X3	2F7		COUPLING M 5 D 4		0791 00 111 2	FADENFUEHRUNG	4A3 4B2
K999 21 021 5	EINSATZ INSERT 105CKX5	11G9	K999 23 022 8	DICHTRING	2G11	K999 24 039 2	VERSCHRAUBUNG	4K6 4M5	0791 00 111 3	SCHELLE	4A2
K999 21 031 4	BAND TAPE 816B/5	14L11	K999 23 024 8	DICHTRING GASKET RING G12X19X3	3H6	K999 24 039 4	VERSCHRAUBUNG	2D1 4D10			
K999 21 069 5	SCHLIESSER LOCKER 816S/5	14H10	K999 23 055 8	DICHTRING GASKET RING G17X23X3	2H10		COUPLING R 1/8"D 6				
K999 21 081 8	KLEMMHEBEL CLAMPING LEVER KGR2 M 8X15	14D6 14D7	K999 23 258 1	NADELLAGER NEEDLE BEARING NK 9/12	2J5 2J7	K999 24 039 8	T STUECK T PIECE STECKB.D 3	2K9			
K999 21 089 1	SCHLOSS KPL LOCK CPL IDEAL	12D3 12E3 13F7 13F11 13H11	K999 23 753 1	NADELLAGER NEEDLE BEARING BH88 12*X19*X12	3J6	K999 26 002 9	VERDICHTER	1 14K11			
K999 22 033 4	ZYLINDER CYLINDER D19X30	4C9 4C10	K999 23 791 1	FREILAUF FREE WHEEL RCB- 08 12 14	3H8	K999 26 003 0	VERDICHTER	14K12			
K999 22 037 4	ZYLINDER CYLINDER D12X25	1F10	K999 24 001 8	WI-STUECK R 1/8"	4K7	K999 26 003 1	VERDICHTER	14K12			
K999 22 051 9	VENTIL VALVE MANUELL- G1/8"	4J5	K999 24 003 9	WI-STUECK R 1/4"	4M5	K999 31 072 0	KERBSTIFT DOWEL PIN S7 3X10	2C5 2F6			
K999 22 063 5	SCHLAUCHTUELLE HOSE SOCKET R 1/4-D 6	4M5	K999 24 026 9	BLINDSTOPFEN BLIND PLUC G 1/8"	4K7	K999 31 097 7	KERBSTIFT DOWEL PIN S67 4X20	3M7			
K999 22 066 6	ZYLINDER CYLINDER D16X15	3C9	K999 24 030 2	DOPPELNIPPEL DOUBLENIPPLE R1/8-R1/8"	4J6	MG43 00 003 5	LASCHE	4L1 4M3			
K999 22 070 3	VENTIL VALVE MAGNET-3/2	4K7	K999 24 030 3	DOPPELNIPPEL DOUBLENIPPLE R1/4-R1/8"	4L7 4M7	MG43 00 003 6	6KT.-SCHRAUBE MBX12	4L3			
K999 22 070 5	ANSCHLUSSPLATTE PLATE 1-FACH	4L7	K999 24 030 4	REDUZIERNIPPEL REDUCING NIPPLE R1/4-R1/8"	4K6 4M5	MG43 00 050 5	UNTERTEIL LINKS	4K4			
K999 22 070 8	ANSCHLUSSPLATTE PLATE 4-FACH	4M7	K999 24 030 5	VERTEILER DISTRIBUTOR T- R1/8"	4J6	MG43 00 051 0	TRAVERSE	4H2 4H3			
K999 22 071 6	ZYLINDER CYLINDER D10X50	3K5	K999 24 030 6	MUFFE BUSHING R 1/4"	4M5	MG43 00 052 2	UNTERTEIL RE.	4K4			
K999 22 075 2	EINSATZ INSERT	1J4	K999 24 034 1	VERSCHRAUBUNG COUPLING R 1/8"D17	4K7	MG43 00 053 4	TRITTSTREBE	4L3			
K999 22 075 6	ZYLINDER CYLINDER D12X15	2J3	K999 24 036 1	MUFFE BUSHING R 1/8"	4K6 4K7	MG43 00 054 2	QUERSTREBE	4M2			
K999 22 076 7	ZYLINDER CYLINDER D4X6	2C1	K999 24 038 0	REDUZIERNIPPEL R2-R1 1/2	14K12	MG43 00 056 7	GESTELLSCHUH	4L1 4L4 4M3			
K999 23 015 8	DICHTRING GASKET RING	2J9	K999 24 038 3	VERSCHRAUBUNG COUPLING R 1/8"D 4	1F10 4C9 4D9 4J5 4K5 4K7	MG43 00 056 8	LAUFROLLE	4M4			
			K999 24 038 5	VERSCHRAUBUNG COUPLING R 1/8"D 4	4D11 4J5	0791 00 108 1	GARNST ROHR YARN SUPP TUBE LANG	4B2			
						0791 00 012 7	ZYL.SCHR.	4B2			
						0791 00 108 5	GARNST.-ROHR KURZ UNTEN	5K11			
						0791 00 108 6	GARNST.-ROHR KURZ OBEN	5H11			
						0791 00 108 8	GARNST.-ROHR GETEILT	5L11			
						0791 00 109 0	GARNHALTEAM	5K11			
						0791 00 109 1	GARNHALTEAM	5J10			
						0791 00 109 3	SCHLEIBE A5,5	5H10 5K10			
						0791 00 109 4	LINSENSCHRAUBE M5X25	5H10 5K10			
						0791 00 109 5	MUTTER	5H10 5J11			
						0791 00 109 6	FADENFUEHRUNG	5J11			

Teile-Nr.	Benennung	Bildtafel	Teile-Nr.	Benennung	Bildtafel	Teile-Nr.	Benennung	Bildtafel	Teile-Nr.	Benennung	Bildtafel
K993 03 176 7	SENKSCRAUBE SCREW M6X10	12H2 13F9 14C2	K993 06 716 7	SCHRAUBE SCREW M4X10	14K10		NUT M3	13F7 13F11	K993 91 081 7	SCHRAUBE SCREW M4X8	2M4
K993 03 178 7	SENKSCRAUBE SCREW M6X16	4H2	K993 06 736 7	SCHRAUBE SCREW M5X10	11L2 5C17	K993 34 056 7	MUTTER NUT M4	2F8 3F2 3K7 3M7 12K2 14C1 14C3 14E3 14H3	K993 91 081 8	ZYL.SCHR. M4X8	2M2
K993 03 724 7	SENKSCRAUBE SCREW M3X6	1J1	K993 07 355 7	SCHRAUBE SCREW M4X8	5B1 11F4 11G11 11H1 11H3 11M2	K993 34 057 7	MUTTER NUT M5	1J6 1L5 2J10 2J11	K993 91 082 7	SCHRAUBE SCREW M4X10	2M7 3M5
K993 03 765 7	SENKSCRAUBE SCREW M4X8	1G6	K993 07 375 7	SCHRAUBE SCREW M5X8	1F5 1G8 2H12	K993 34 059 7	MUTTER NUT M8	14H8	K993 91 083 7	SCHRAUBE SCREW M4X12	1K4 1K8 2F6 4L11 11C2 11G3 11H7
K993 03 768 7	SENKSCRAUBE SCREW M4X16	2B5	K993 15 115 0	HALBRD.HOLZSCHR 4X20	1K10 4E1	K993 39 106 7	RAENDELSCHR. M5X10	14E7	K993 91 083 8	SCHRAUBE SCREW M4X12	1D12 2H6 2L7 11H2
K993 03 786 7	SENKSCRAUBE SCREW M5X10	1J10	K993 15 115 7	HOLZSCHRAUBE WOOD SCREW 4X20	5B11 11K10	K993 41 016 7	RAENDELMUTTER KNURLED NUT M4	14B3	K993 91 084 7	SCHRAUBE SCREW M4X16	1K4 2E3 2F9 2J3
K993 06 092 7	SCHRAUBE SCREW M3X4	2J10	K993 15 156 7	HOLZSCHRAUBE WOOD SCREW 5X25	11K9	K993 41 018 7	RAENDELMUTTER KNURLED NUT M6	14B9	K993 91 084 8	ZYL.SCHR. M4X16	2F7 2J4
K993 06 093 0	ZYL.SCHR. M3X5	1J3	K993 16 063 6	SENKSCRAUBE SCREW 2,7X15	4D3	K993 41 117 8	RAENDELMUTTER KNURLED NUT M 3	12D3 13E7 13E11	K993 91 085 7	SCHRAUBE SCREW M4X18	2H10
K993 06 093 7	SCHRAUBE SCREW M3X5	3M7	K993 19 034 7	SCHEIBE DISC 3,2	4G10	K993 41 119 8	RAENDELMUTTER KNURLED NUT M 4	13F4 13H5 14G2	K993 91 085 8	ZYL.SCHR. M4X18	2G10
K993 06 095 7	SCHRAUBE SCREW M3X8	12J1 13J7 14B2	K993 19 036 7	SCHEIBE DISC 4,3	1G1 1L5 3F2 4H12 11D5 12F3 13F4 13H5 14C1 14C3 14G3 14K10	K993 43 121 7	SCHRAUBE SCREW M8X16	5G9 5G10	K993 91 088 7	SCHRAUBE SCREW M4X25	3K5 3K7
K993 06 096 7	SCHRAUBE SCREW M3X10	4F11	K993 19 037 0	SCHEIBE DISC B5,3	1H10	K993 52 094 0	GEWINDESTIFT THREADED PIN M4X5	1K10 14B1	K993 91 088 8	ZYL.SCHR. M4X25	1E11
K993 06 097 7	SCHRAUBE SCREW M3X12	2B2	K993 19 037 7	SCHEIBE DISC B5,3	1E10 1J10 2G5 4F8	K993 52 103 0	GEWINDESTIFT THREADED PIN M5X4	3H6	K993 91 091 8	SCHRAUBE SCREW M4X40	2G7
K993 06 098 7	SCHRAUBE SCREW M3X16	4J10	K993 19 038 7	SCHEIBE DISC B6,4	2F7 2L3 4B2 14B10	K993 52 105 0	GEWINDESTIFT THREADED PIN M5X6	1D2	K993 91 103 7	SCHRAUBE SCREW M5X12	1H1 1K1
K993 06 133 7	SCHRAUBE SCREW M4X5	2C3	K993 19 040 7	SCHEIBE DISC B8,4	4A5 4C10 4C11 4D4 4F1 4G2 5C10 12G3 13F9 14B4 14C4 14C6 14H9	K993 52 113 0	GEWINDESTIFT THREADED PIN M5X30	2J10	K993 91 103 8	ZYL.SCHR. M5X12	3L5
K993 06 135 7	SCHRAUBE SCREW M4X8	2D2	K993 19 041 7	SCHEIBE DISC B10,5	11H12	K993 53 105 0	GEW.STIFT M5X8	11B2	K993 91 104 7	SCHRAUBE SCREW M5X16	2D9 2F5 3G6
K993 06 136 7	SCHRAUBE SCREW M4X10	2L5	K993 19 041 7	SCHEIBE DISC B10,5	11H12	K993 63 159 7	SCHRAUBE SCREW M8X60	4D3	K993 91 104 8	ZYL.SCHR. M5X16	2G10
K993 06 137 7	SCHRAUBE SCREW M4X12	3G6 4G5	K993 19 046 7	SCHEIBE B19	4C2 5L11	K993 80 079 0	STIFTSCHRAUBE SCREW M3X40	3D8	K993 91 105 7	SCHRAUBE SCREW M5X18	3K7
K993 06 138 7	SCHRAUBE SCREW M4X16	3F4	K993 25 048 7	FLUEGELMUTTER FLY NUT M8	5C10	K993 90 070 0	SCHALTBUEGEL	14H3	K993 91 106 7	ZYL.SCHR. M5X20	11J11
K993 06 142 7	SCHRAUBE SCREW M4X25	4J12	K993 30 036 7	SCHEIBE DISC 4,3	3K5 13K2	K993 90 400 8	SCHRAUBENDREHER SCREWDRIVER F.I.6KT.SW 1,5 X40	5C7	K993 91 122 8	ZYL.SCHR. M6X10	4C4
			K993 34 054 7	MUTTER	3H10 4H10 12D3	K993 91 070 8	SCHRAUBE SCREW M3X6	2M8	K993 91 124 7	SCHRAUBE SCREW M6X16	3H7
						K993 91 080 7	SCHRAUBE M4X6	1L4 1M4	K993 91 126 7	SCHRAUBE	1F4 3C7 11C4

Teile-Nr.	Benennung	Bildtafel	Teile-Nr.	Benennung	Bildtafel	Teile-Nr.	Benennung	Bildtafel	Teile-Nr.	Benennung	Bildtafel
K993 91 129 7	M6X20 SCHRAUBE SCREW	2L4 11J11	K993 96 160 7	SCHRAUBE SCREW	1F2 1F3 11C9 11D4 11E2	K994 17 015 4	M4X20 RAENDELMUTTER	1F6 1K6		PIPE RIVET C 4 X 5	13K9 13L7 14B1 14F7
K993 91 130 7	M6X30 SCHRAUBE SCREW	2F8	K993 96 180 0	SCHRAUBE SCREW	3C4	K994 25 072 7	SCHEIBE	14E7	K994 49 511 0	ROHRNIET PIPE RIVET	12L3 12L11 13M4 14B3 14G6
K993 91 132 7	M6X35 ZYL.SCHR.	3G6 3K9	K994 03 201 7	SCHRAUBE SCREW	4A6 4F3	K994 27 171 0	KERBSTIFT DOWEL PIN	11G7	K994 49 513 0	ROHRNIET PIPE RIVET	14K2
K993 91 144 7	ZYL.SCHR.	1J9	K994 03 201 7	SCHRAUBE SCREW	4A6 4F3	K994 33 054 0	HALBRD.KERBNAGE 2,3X7	11F2	K994 80 146 7	SCHEIBE C 4 X 8	2K4
K993 91 146 7	SCHRAUBE SCREW	14C6	K994 04 109 7	SCHRAUBE SCREW	3H10	K994 33 073 7	KERBNAGEL 3X6	2E3	K994 80 148 7	SCHEIBE DISC	4D1 4F1 11M8
K993 91 146 8	ZYL.SCHR. M6X20	14C4	K994 04 109 7	SCHRAUBE SCREW	3H10	K994 33 075 0	KERBNAGEL SLOT NAIL	2J3 2J5	K994 80 148 7	SCHEIBE DISC	4D1 4F1 11M8
K993 91 148 7	SCHRAUBE SCREW	4C10 4C11 4G1 4H2	K994 04 149 7	SCHRAUBE SCREW	1L5	K994 38 022 7	SPANNHUELSE CLAMPING SLEEVE	1D3	K995 14 021 7	RAENDELMUTTER KNURLED NUT	2E8 4A10
K993 91 152 7	SCHRAUBE SCREW	11M8	K994 04 151 7	SCHRAUBE SCREW	11D5	K994 38 063 8	SPANNHUELSE CLAMPING SLEEVE	2D6	K995 14 034 0	RAENDELMUTTER KNURLED NUT	13K2
K993 91 155 7	SCHRAUBE SCREW	4F1	K994 04 179 7	SCHRAUBE SCREW	2C10	K994 38 064 8	SPANNHUELSE CLAMPING SLEEVE	2H10	K995 19 013 8	SPANNHUELSE CLAMPING SLEEVE	1J3
K993 91 180 7	SCHRAUBE SCREW	2C8	K994 04 184 7	SCHRAUBE SCREW	1L5	K994 38 067 8	SPANNHUELSE CLAMPING SLEEVE	1J3	K995 34 061 7	MUTTER NUT	4C2 5K17
K993 91 187 7	SCHRAUBE SCREW	2E7 11H12	K994 04 208 7	SCHRAUBE SCREW	13F3	K994 38 082 8	SPANNHUELSE CLAMPING SLEEVE	1C8	K995 43 675 0	STIFT PIN	1A9 2B10 2D11
K993 92 069 8	GEWINDESTIFT THREADED PIN	1F2	K994 04 217 7	6KT.SCHR. M6X35	4B10	K994 38 107 8	SPANNHUELSE CLAMPING SLEEVE	2H1	K995 5 M 6X 8		
K993 92 070 8	GEWINDESTIFT THREADED PIN	11B4	K994 04 280 7	SCHRAUBE SCREW	4K1 4K2 4K3 4L2	K994 38 125 8	SPANNHUELSE CLAMPING SLEEVE	14B6	K996 01 084 8	SICHERGS RING CIRCLIP	1M8 3C4
K993 92 099 8	GEW.STIFT M5X6	1H8	K994 04 322 7	SCHRAUBE SCREW	4J1 4K4	K994 38 489 0	SPANNSTIFT TENSION PIN	2H2	K996 01 085 8	SICHERGS RING CIRCLIP	2J7
K993 92 109 7	GEWINDESTIFT THREADED PIN	3D3	K994 04 731 8	SCHRAUBE SCREW	3G7	K994 39 512 0	HUTMUTTER CAPNUT	2J5	K996 02 127 8	SICHERGS RING CIRCLIP	106 1D9 11C6 11B8
K993 92 111 8	GEW.STIFT M6X10	11C7	K994 05 034 7	MUTTER NUT	1H3 4G10	K994 46 101 7	SCHRAUBE SCREW	1D11 1E11	K996 06 017 0	KUGEL BALL	1E5 11C5
K993 92 122 8	GEW.STIFT M8X12	11L10	K994 05 036 7	MUTTER NUT	1D11 2C2 2G5 2M4 3C6 3K7 4F3	K994 46 124 7	SCHRAUBE SCREW	4D1	K996 06 020 0	KUGEL BALL	2E10
K993 94 102 8	GEWINDESTIFT THREADED PIN	2J11	K994 05 038 7	MUTTER NUT	4G3 4G4 4G5 4H5 11L1 14H2	K994 46 346 8	SCHRAUBE SCREW	2E8 4A10	K996 07 006 8	SICHERGSSCHEIBE SAFETY DISC	1G6
K993 95 092 8	GEW.STIFT M5X6	3J6	K994 05 040 7	MUTTER NUT	4D4 4J3 4L2 14H9	K994 46 534 7	SCHRAUBE SCREW		K996 07 008 8	SICHERGSSCHEIBE SAFETY DISC	1B10 1D3
K993 96 042 7	SCHRAUBE SCREW	1F3	K994 05 041 7	MUTTER NUT	4J2	K994 49 501 0	ROHRNIET PIPE RIVET	12E3 13G5 13J2 13L7 13L11	K996 07 010 8	SICHERGSSCHEIBE SAFETY DISC	1K9
K993 96 077 0	SCHRAUBE SCREW	2C5	K994 10 093 0	STIFTSCHRAUBE SCREW	2H8 3D6 3E2	K994 49 510 0	ROHRNIET	12G2 12K2 13F10	K996 07 011 8	SICHERGSSCHEIBE SAFETY DISC	4M4
K993 96 158 7	ZYL.SCHR.	1G5									

Teile-Nr.	Benennung	Bildtafel	Teile-Nr.	Benennung	Bildtafel	Teile-Nr.	Benennung	Bildtafel	Teile-Nr.	Benennung	Bildtafel
K996 07 012 8	SICHERGSSCHEIBE SAFETY DISC 9	2G4		H 6,5X0,7			CONTAINER 70LT		K999 20 127 7	MIKROSCHALTER MICRO SWITCH 1005.1401	4G10
K996 08 348 4	RI KUGELLAGER BALL BEARING 8X19X6	2G5	K998 85 065 0	SIMMERRING SEALING RING BA 7X16X5	2K5	K999 19 024 4	SCHLAUCH HOSE LW 40	14M11	K999 20 131 1	STECGERGAEHUSE PLUG CASE 4 POLIG	2C2
K996 08 534 0	RI KUGELLAGER BALL BEARING 6004.2ZR	107	K998 85 115 0	SIMMERRING SEALING RING BA 9X18X6	2H5 2K7 2M11	K999 19 026 6	FILTER FILTER	14J10	K999 20 131 2	GEHAEUSE HOUSING 4 POLIG	4J7
K996 08 831 0	RI KUGELLAGER BALL BEARING 8X16X5	5B1 5B3 11H1 14K5	K998 86 007 0	RING RING OR 3 X 1	1D5 11A4	K999 20 034 1	SHELLE CLAMP ISO 7 - 10	11K10	K999 20 131 3	BUCHSE BUSHING 163304-2MNL MS VER	4J7
K996 13 136 0	KUGELKNOPF SPHERIC BUTTON C 25 M 6	4H2 12G3 13E9 14B3	K998 86 072 0	O-RING RING 12X1,5	1C3	K999 20 043 1	ABDECKKAPPE COVER CAP 5 PA-PG9-1	4H11	K999 20 131 4	STIFT PIN 163305-2MNL MS VER	1H4 2C2
K996 19 019 0	KERBNAGEL A 16X30	11L10	K998 86 110 0	O-RING RING 15X2	2L5	K999 20 044 0	WUERGENIPPEL TWIST NIPPLE PG16	4H5 4M8	K999 20 134 5	SIFLEX-LEITUNG	1H8
K996 23 023 0	KUGELLAGER BALL BEARING 1203 TV (17X40X12)	1D9 11C8	K998 86 346 0	O-RING RING 40X2	11B6	K999 20 083 2	SCHALTER SWITCH SRUTB 16	11K8	K999 20 136 5	WUERGENIPPEL TWIST NIPPLE PG36	4D3
K996 23 068 0	KUGELLAGER BALL BEARING 15X 42X13	1D6 11C6	K998 86 500 0	O-RING RING 3,3X2,4	1E4 2E6 2K9 3C4	K999 20 085 4	BEF SCHELLE CLAMP VERNICK. 604-7	2C3	K999 20 136 8	ROHR PIPE PG 16	4G6
K996 28 080 0	DICHTRING GASKET RING A 13X19X2	4K6 4L5	K998 87 017 8	RING RING A 20 X1,2	2L11	K999 20 085 5	BEF SCHELLE CLAMP VERNICK. 604-9	14K9	K999 20 142 3	SIGNALFOLIE	1M4
K996 35 029 0	DICHTRING GASKET RING C 12X16	2E5	K998 88 104 0	PASS SCHEIBE WASHER 5X10X0,3	1G8	K999 20 089 0	KABELBAND CABLE TAPE 203MM LANG	4D9	K999 20 150 5	KIPPSCHALTER TUMBLER SWITCH 1 POLIG	4F9 4F12
K996 38 058 0	DICHTRING GASKET RING A15X24X7	2F6	K998 88 110 0	PASS SCHEIBE WASHER 10X16X0,3	2F8 2G4	K999 20 089 5	STECKER PLUG MES 100	4K9	K999 20 151 7	MAGNET MAGNET GL40E/76	2J2
K996 49 011 0	RIEMENSCHLEIBE PULLEY A 67-L	4B8 4D5	K998 88 122 0	PASS SCHEIBE WASHER 30X42X0,3	1D7	K999 20 092 2	WUERGENIPPEL TWIST NIPPLE PG 11	11H12	K999 20 153 3	KABELSCHUH TERMINAL PVC-ISOLAT	4E5 11K11
K996 49 014 0	RIEMENSCHLEIBE PULLEY A 80-L	4B8 4D5	K998 88 210 0	PASS SCHEIBE WASHER 10X16X1	4M4	K999 20 093 6	BEF SCHELLE CLAMP VERNICK. 605-13	2C2 11K10	K999 20 160 6	MIKROSCHALTER MICRO SWITCH Z-15GK 355	4J11
K996 79 037 0	BOHRBUCHSE A 3X8	14C11	K998 91 014 0	SPRENGRING SPRING RING SB11	1D7 1G5	K999 20 101 8	KABELKANAL CABLE CHANNEL 33X30/BA6	4M7	K999 20 163 4	STEUERLEITUNG CONTROL LEAD 4 X 0,35	1G4
K996 79 057 0	BOHRBUCHSE A 4X8	14B11	K999 18 905 7	LEITUNG CABLE 3 X1,0 SW	4F5	K999 20 104 6	WUERGENIPPEL TWIST NIPPLE PG 9	4J11	K999 20 166 1	FEDERLEISTE SPRING BAR GSW31FS	4M9
K997 15 350 0	STECKHUELSE RECEPTACLE 6,3-1	4M7	K999 18 909 7	LEITUNG CABLE 4 X1,0 GR	4F5 11K10	K999 20 106 5	STECKER PLUG MESEI 60F	4F11	K999 20 167 8	STECKDOSE SOCKET 71206-076	4K9
K997 50 236 0	FEINSICHERUNG FUSE M 1,60 D	4M8	K999 18 913 7	LEITUNG CABLE 5 G1,0 GR	4E5 11K11	K999 20 106 6	KUPPLUNG	4K7	K999 20 169 9	SCHALTER SWITCH INDUKTIV M12 X 1	4H10
K998 68 029 8	SPANNRING CLAMPING RING 5	3C9	K999 19 023 6	SIEB FILTER METALL	14J10	K999 20 111 3	HUELSE BUSH B6 GLASKLAR	4M7	K999 20 171 9	LICHTSCHRANKE	1L4
K998 83 021 8	HALBMONDRING HALFMOONRING H 6 X0,7	1B10	K999 19 023 7	SCHLAUCH HOSE LW 50	14H10	K999 20 124 3	ISOLIERSTOFFGEH INSUL HOUSING CI-D	4K9	K999 20 177 4	MAGNET	14F6
K998 83 022 8	HALBMONDRING HALFMOONRING	2F5	K999 19 024 3	BEHAELTER	14L10	K999 20 125 6	DRUCKTASTER PRESS SENSOR SCHWARZ	4K12	K999 20 181 1	DIODENSTECKER MAS7100S	4K7
									K999 20 181 7	SCHUTZSCHALTER SWITCH 2,5-4 A	4H5
									K999 20 182 4	PEGELUMSETZER 1 SCL4010B	4G7