



Teileliste und Näheinrichtungen
Spare Parts List and Sewing Equipment

973 -205/ -305

DÜRKOPP ADLER AG

Teile-Nr./Part-No.: 0791 973803a

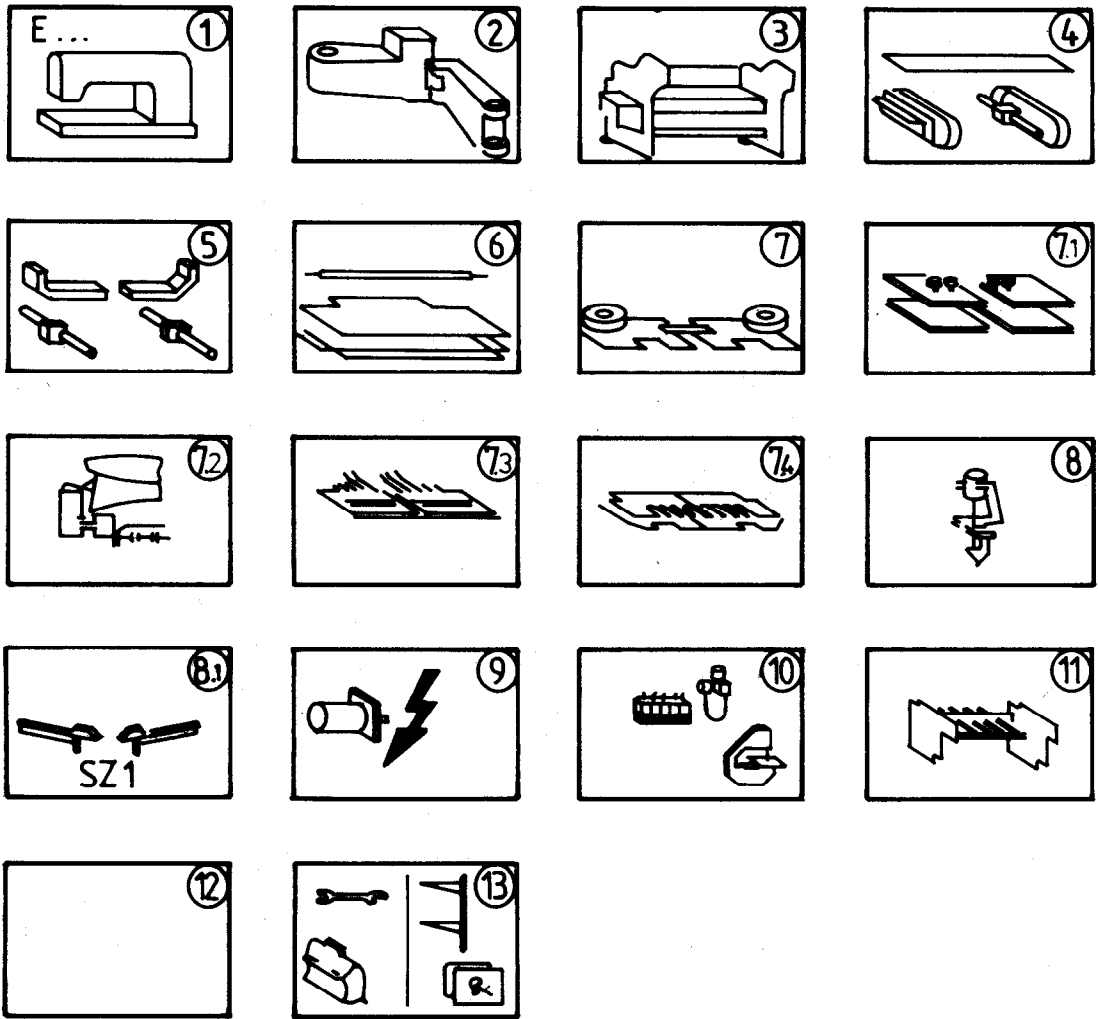

Unterklasse: sub-class:	Bildtafel Nr. Illustration No.																	
	1	2	3	4	5	6	7	7.1	7.2	7.3	7.4	8	8.1	9	10	11	12	13
973-205	X	X	X	X	X	X	X	X	X	X	-	-	X	X	X	X	-	X
973-305	X	X	X	X	X	-	X	X	-	-	X	X	-	-	X	X	-	X

973 43 176 4

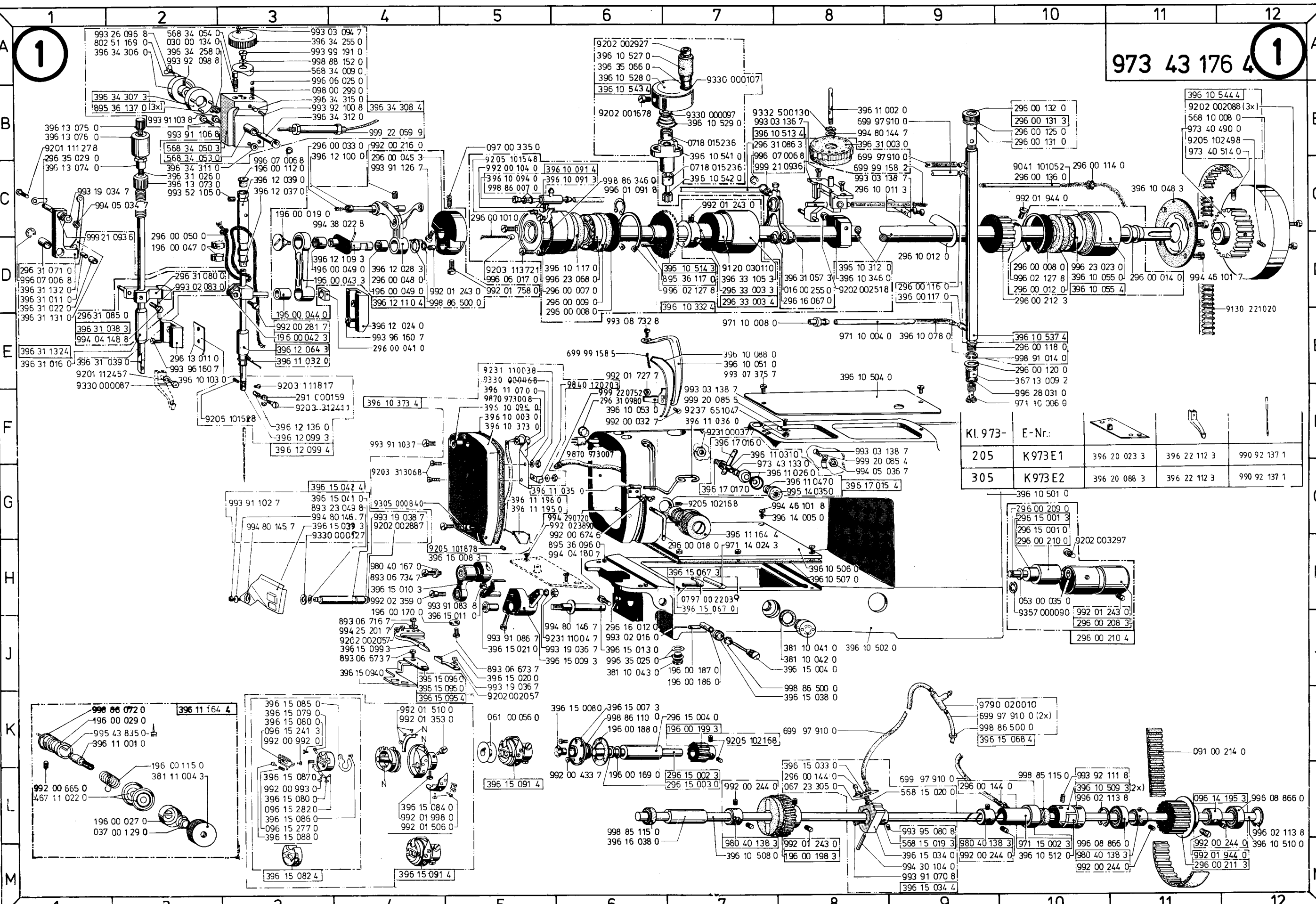

Kl. 973-	E-Nr.:			
205	K973E1	396 20 023 3	396 22 112 3	990 92 137 1
305	K973E2	396 20 088 3	396 22 112 3	990 92 137 1

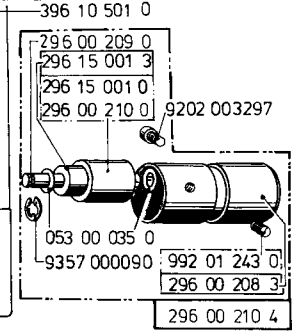

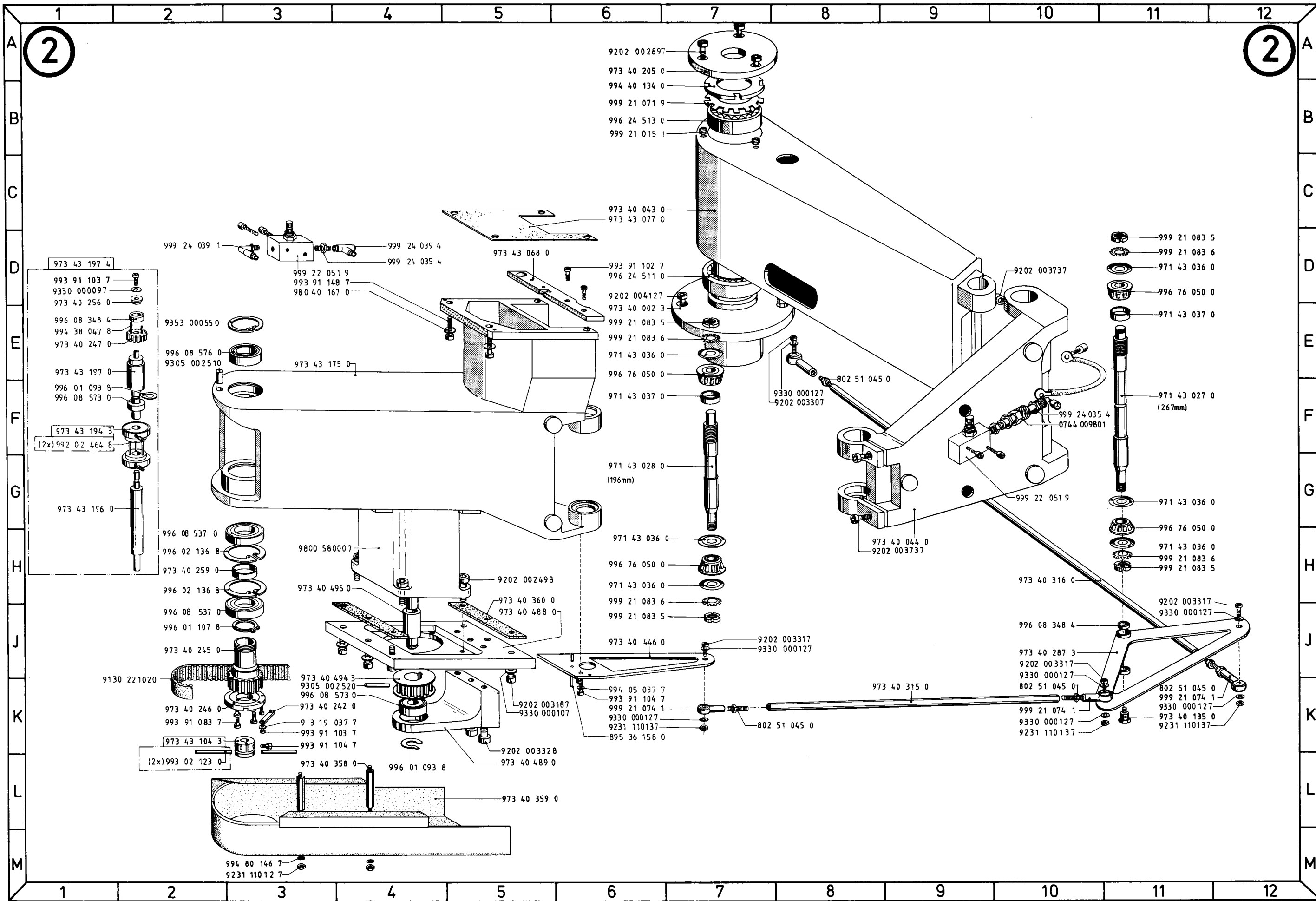

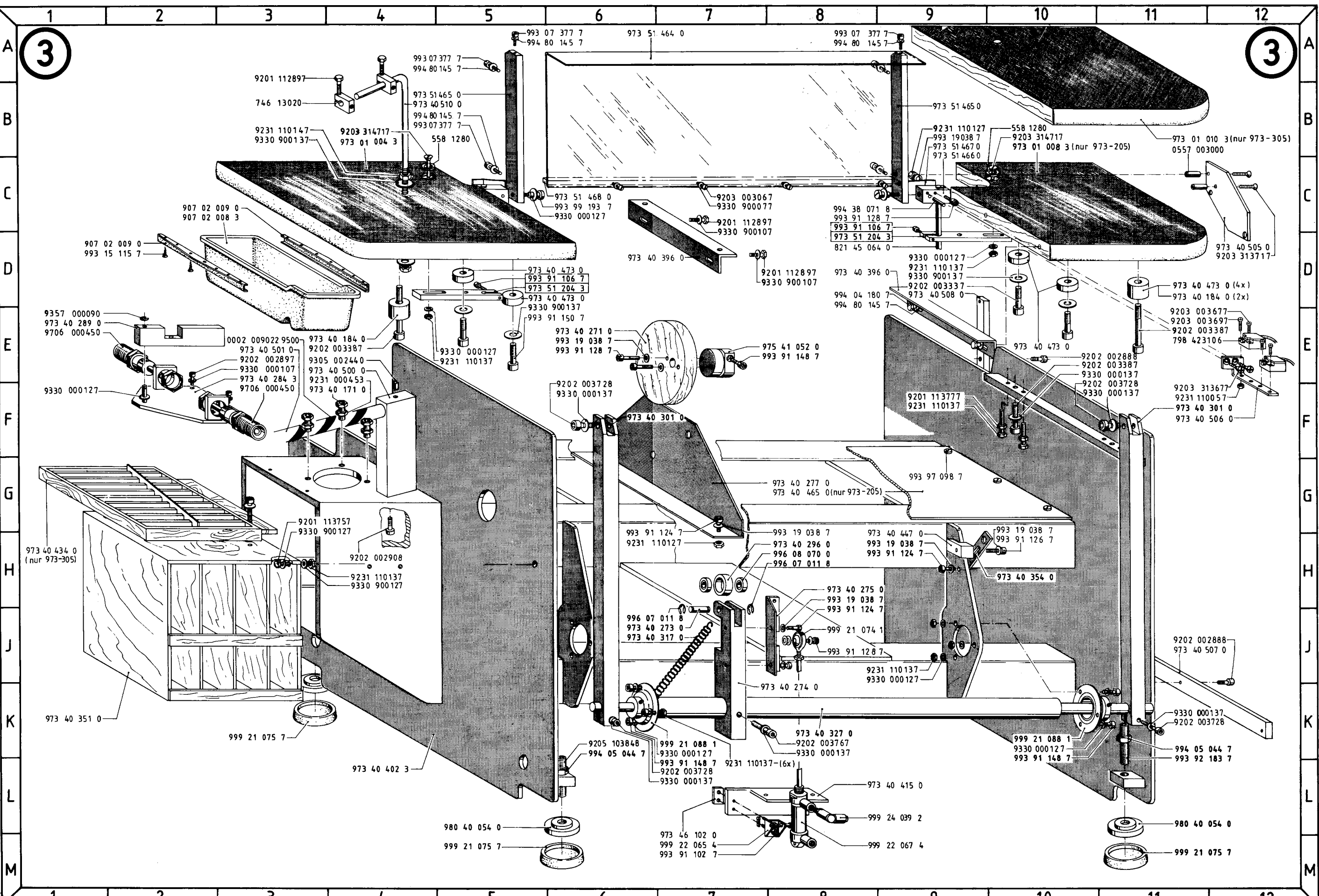

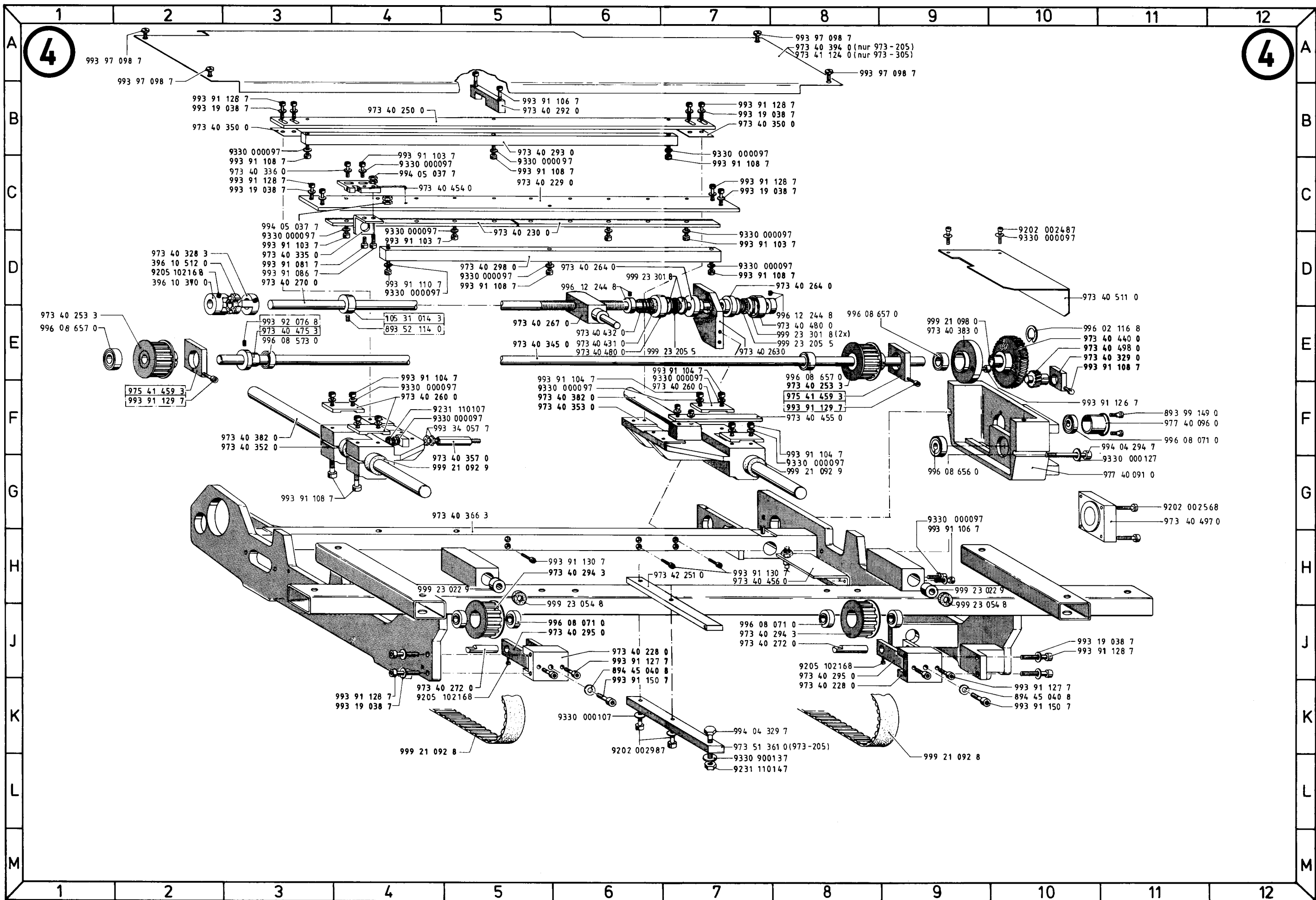

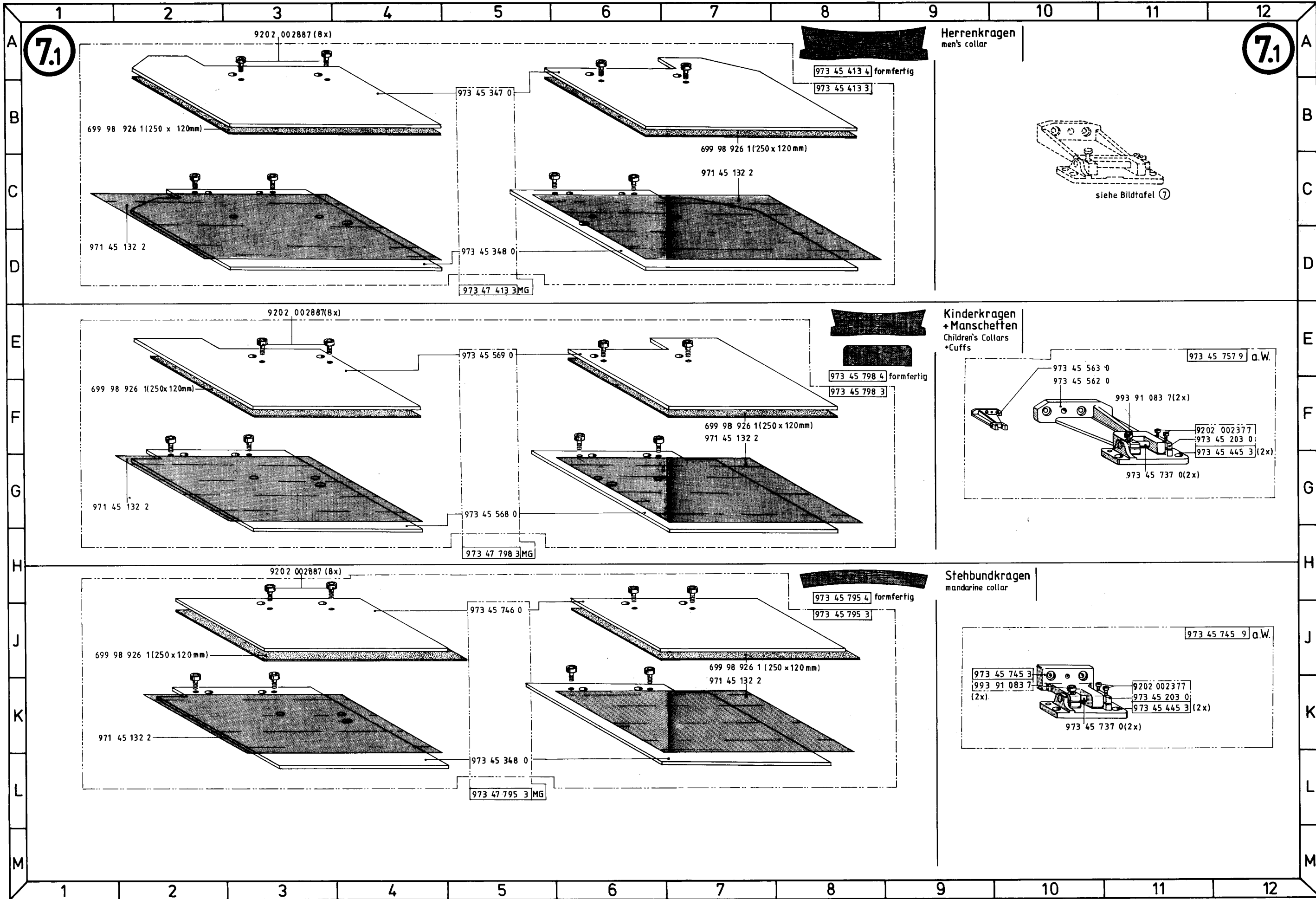

7.2

7.2

Spezialliste
a.W
Special list

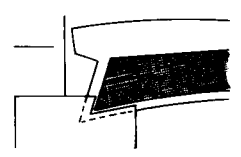

Sicht-Anschlag
stop for alignment

973 51 332 9 a.W.

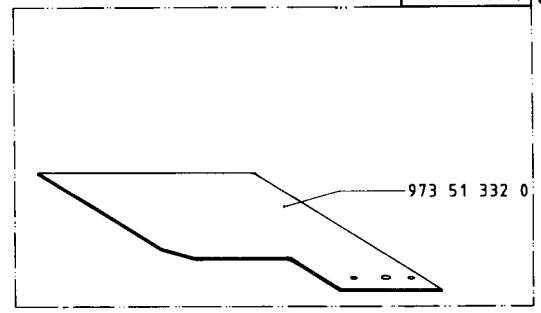

973 51 332 0

Niederhalter fuer umgelegte
Manschetten
Holder for folded cuffs

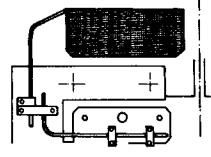

Fest-Anschlag
form stop

973 51 371 9 a.W.

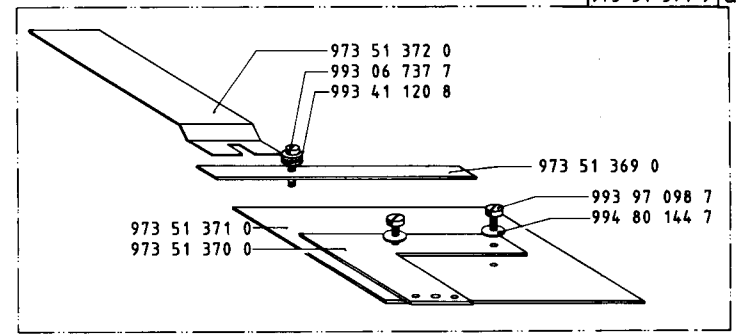

973 51 372 0
993 06 737 7
993 41 120 8

973 51 369 0

973 51 371 0
973 51 370 0

993 97 098 7
994 80 144 7

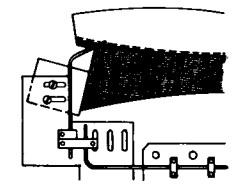

Punkt-Anschlag (fuer imitierten 2 Stueck-Kragen)
Point stop (imitated 2 piece-collar)

973 51 752 9 a.W.

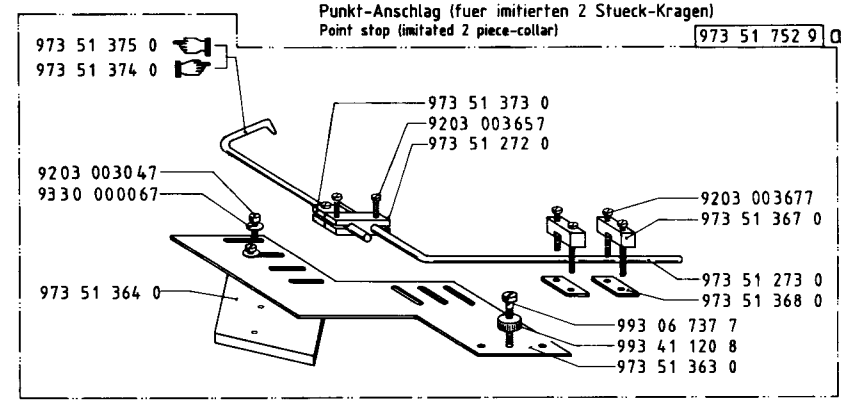

973 51 375 0
973 51 374 0

973 51 373 0
9203 00365 7
973 51 272 0

9203 00367 7
973 51 367 0

973 51 273 0
973 51 368 0

993 06 737 7
993 41 120 8
973 51 363 0

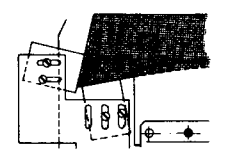

Fest-Anschlag
rigid stop

Kinderkragen
children's collars

973 51 365 9 a.W.

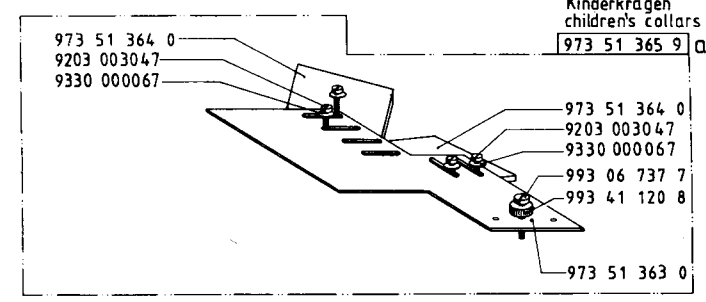

973 51 364 0
9203 00304 7
9330 00006 7

973 51 364 0
9203 00304 7
9330 00006 7
993 06 737 7
993 41 120 8

973 51 363 0

Herrenkragen
men's collars

973 51 363 9 a.W.

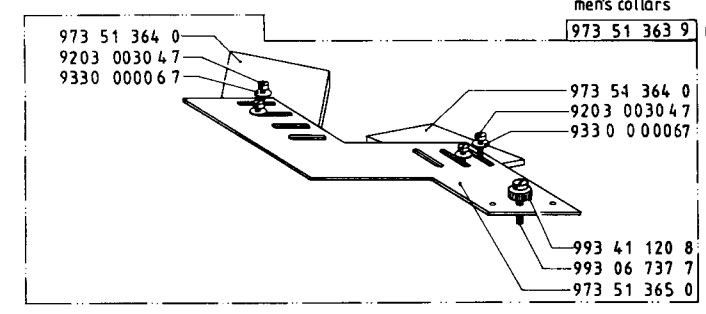

973 51 364 0
9203 00304 7
9330 00006 7

973 51 364 0
9203 00304 7
9330 00006 7

993 41 120 8
993 06 737 7
973 51 365 0

973 45 799 9 a.W.

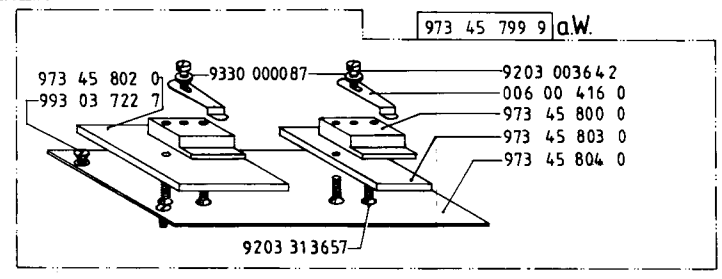

973 45 802 0
993 03 722 7

9330 00008 7

9203 00364 2
006 00 416 0
973 45 800 0
973 45 803 0
973 45 804 0

9203 31365 7

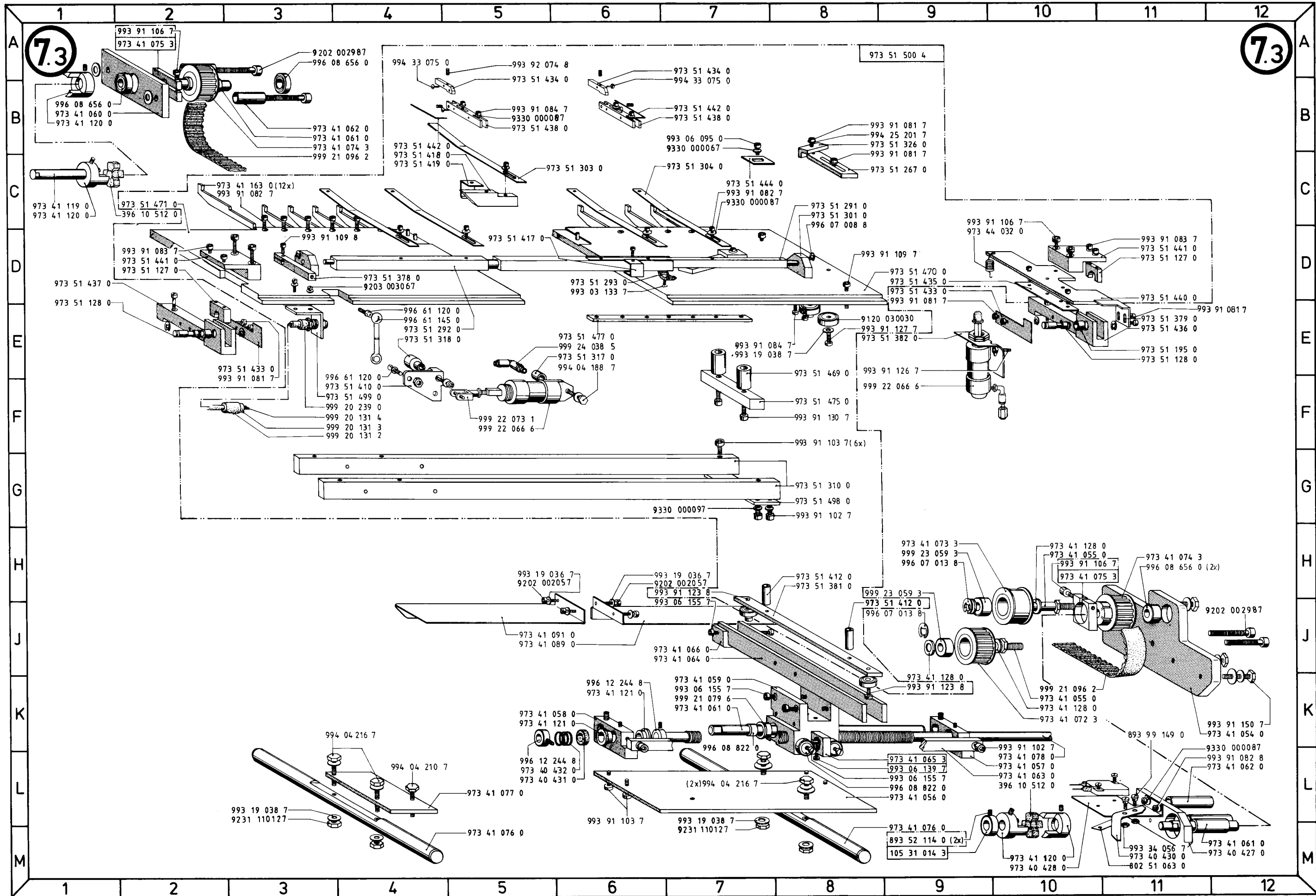

7.4

7.4

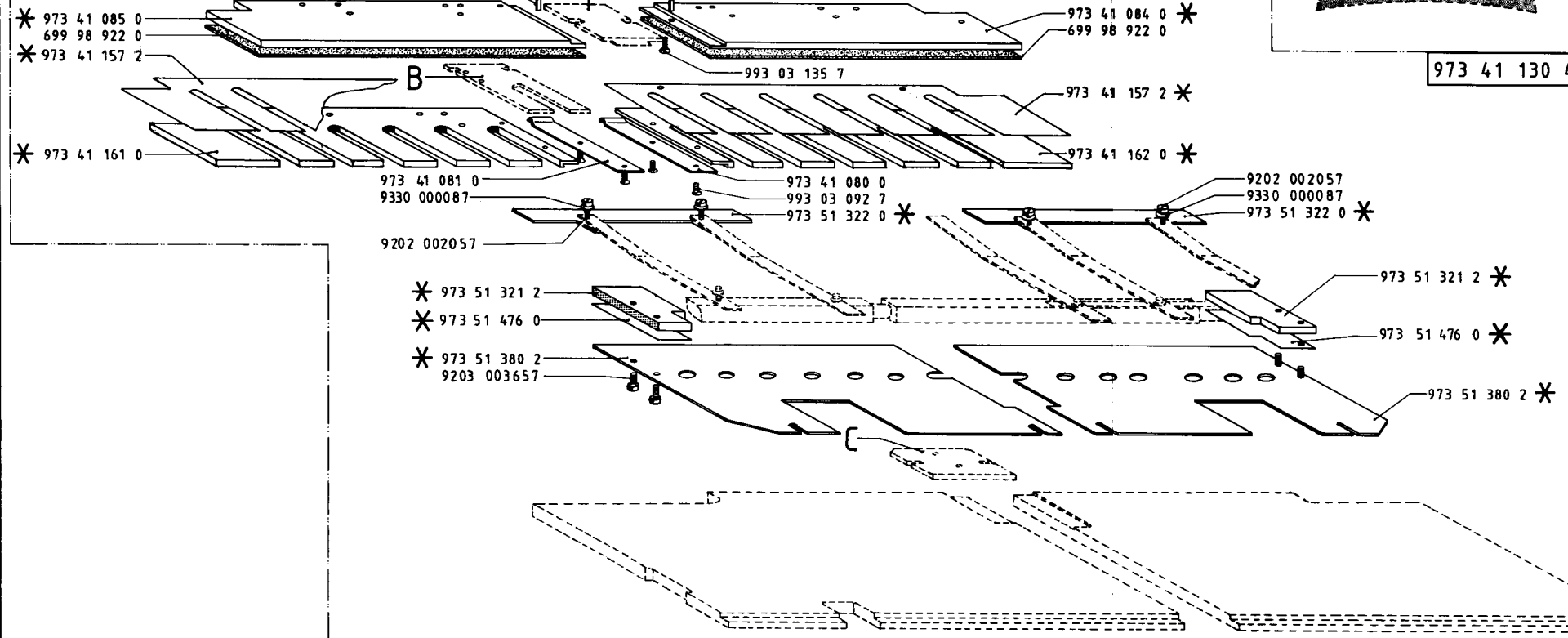

* = Mustergebundene Teile.
Formerstellung im Werk.
Nur bedingt für Eigenfertigung
geeignet.

Pattern dependent parts manufactured
in the works are only conditionally
suitable for self production.

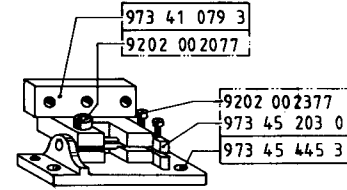

973 41 093 4

Zoll	A	B	C
14,0"	—	973 41 095 3	—
14,5"	973 41 004 0	973 41 096 3	973 51 386 0
15,0"	973 41 005 0	973 41 097 3	973 51 387 0
15,5"	973 41 006 0	973 41 098 3	973 51 388 0
16,0"	973 41 007 0	973 41 099 3	973 51 389 0
16,5"	973 41 008 0	973 41 100 3	973 51 390 0
17,0"	973 41 009 0	973 41 101 3	973 51 391 0
17,5"	973 41 010 0	973 41 102 3	973 51 392 0
18,0"	973 41 011 0	973 41 103 3	973 51 393 0
18,5"	973 41 012 0	973 41 104 3	973 51 394 0
19,0"	973 41 013 0	973 41 105 3	973 51 395 0

973 41 143 4

Zoll	A	B	C
14,25"	973 41 144 0	973 41 133 3	—
14,75"	973 41 145 0	973 41 134 3	973 51 420 0
15,25"	973 41 146 0	973 41 135 3	973 51 421 0
15,75"	973 41 147 0	973 41 136 3	973 51 422 0
16,25"	973 41 148 0	973 41 137 3	973 51 423 0
16,75"	973 41 149 0	973 41 138 3	973 51 424 0
17,25"	973 41 150 0	973 41 139 3	973 51 425 0
17,75"	973 41 151 0	973 41 140 3	973 51 426 0
18,25"	973 41 152 0	973 41 141 3	973 51 427 0
18,75"	973 41 153 0	973 41 142 3	973 51 428 0

973 41 094 4

mm	A	B	C
10	973 41 014 0	973 41 106 3	973 51 397 0
20	973 41 015 0	973 41 107 3	973 51 398 0
30	973 41 016 0	973 41 108 3	973 51 399 0
40	973 41 017 0	973 41 109 3	973 51 400 0
50	973 41 018 0	973 41 110 3	973 51 401 0
60	973 41 019 0	973 41 111 3	973 51 402 0
70	973 41 020 0	973 41 112 3	973 51 403 0
80	973 41 021 0	973 41 113 3	973 51 404 0
90	973 41 022 0	973 41 114 3	973 51 405 0
100	973 41 023 0	973 41 115 3	973 51 406 0
110	973 41 024 0	973 41 116 3	973 51 407 0
120	973 41 025 0	973 41 117 3	973 51 408 0
130	973 41 026 0	973 41 118 3	973 51 409 0

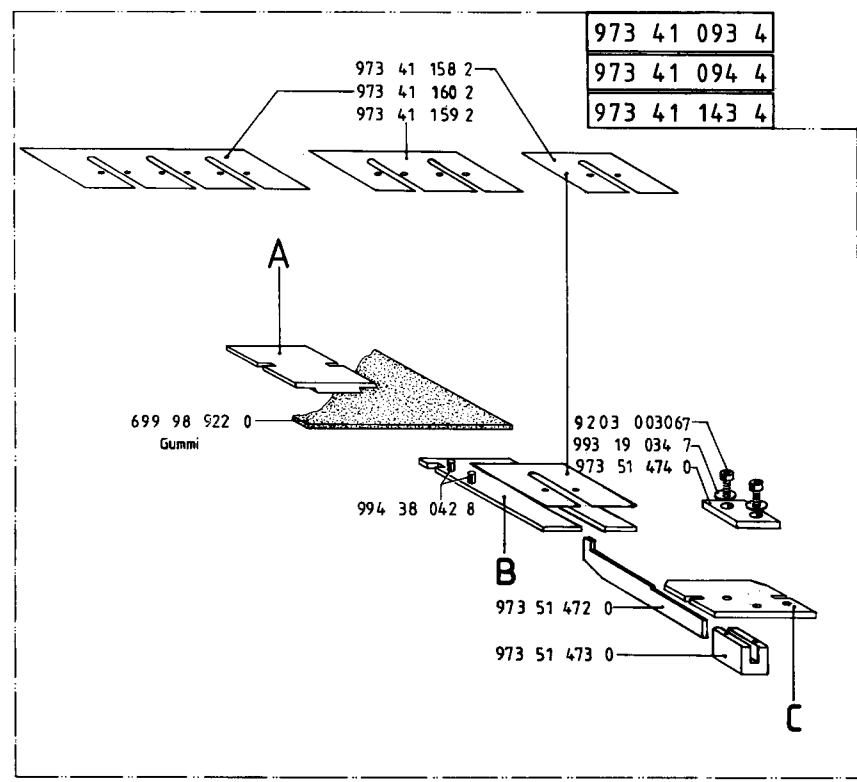

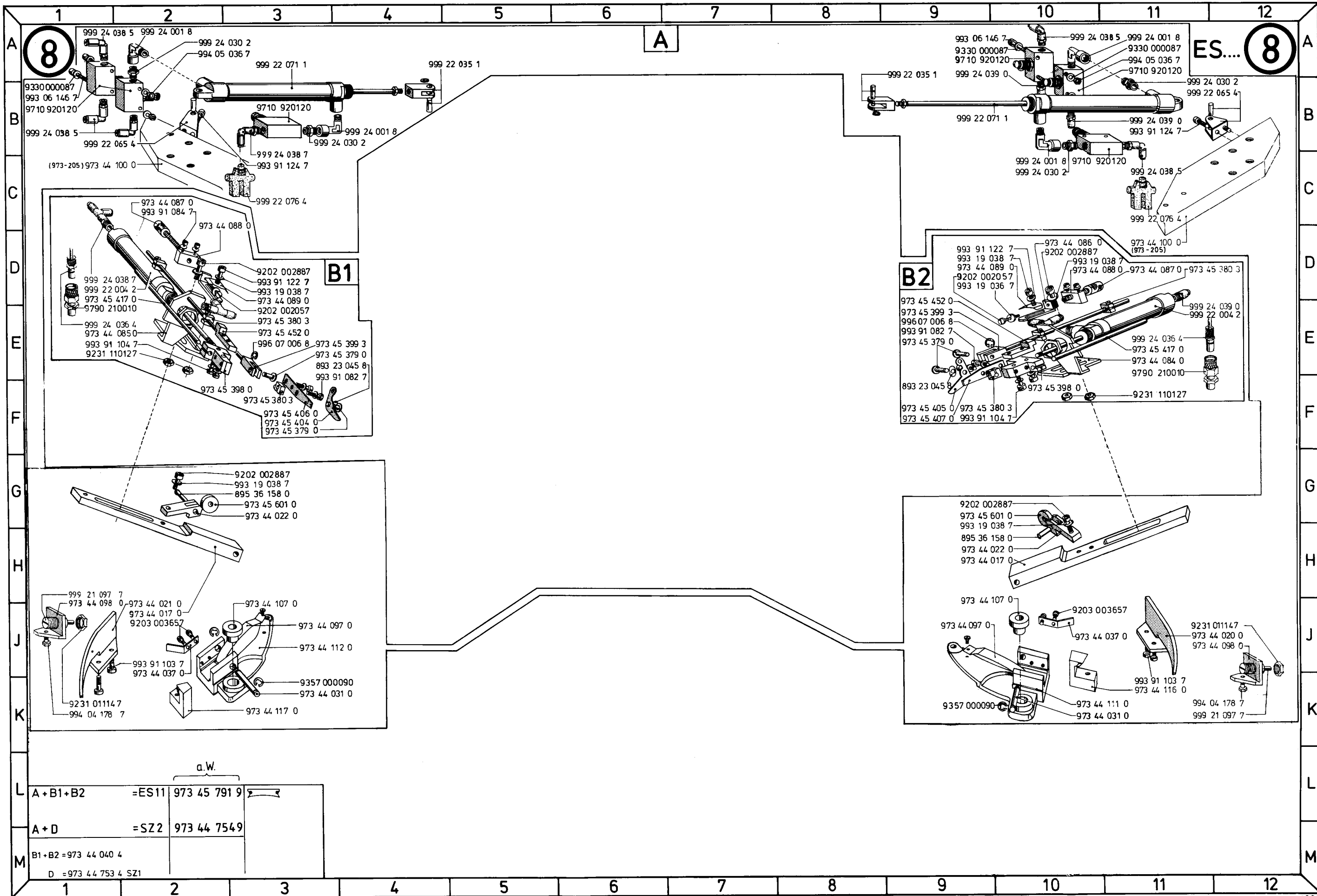

8.1

8.1

D

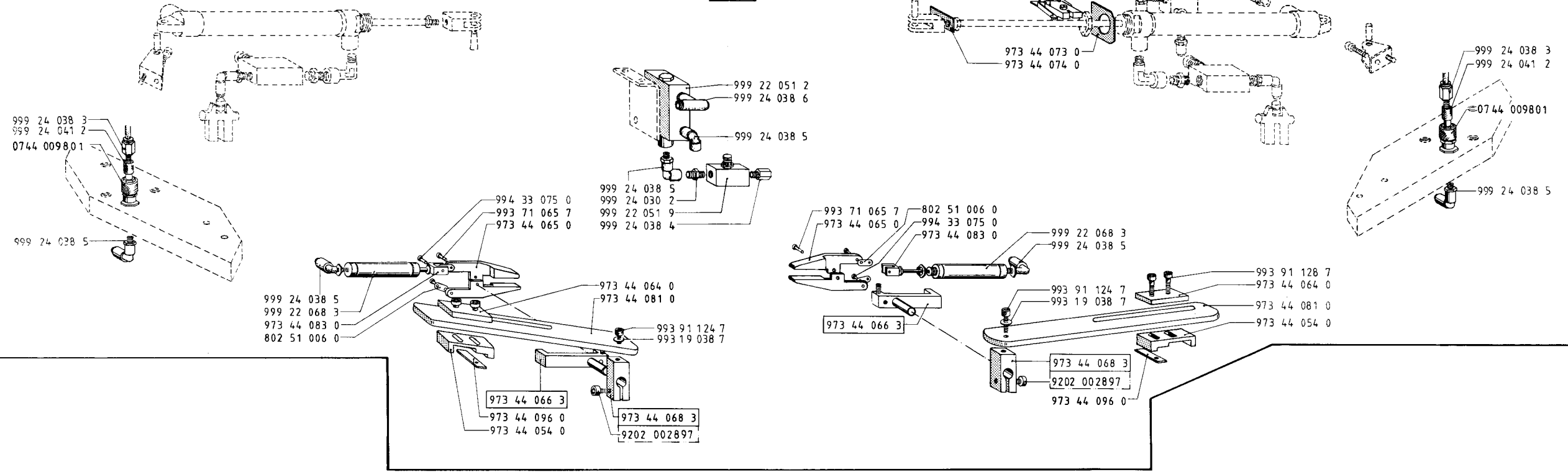

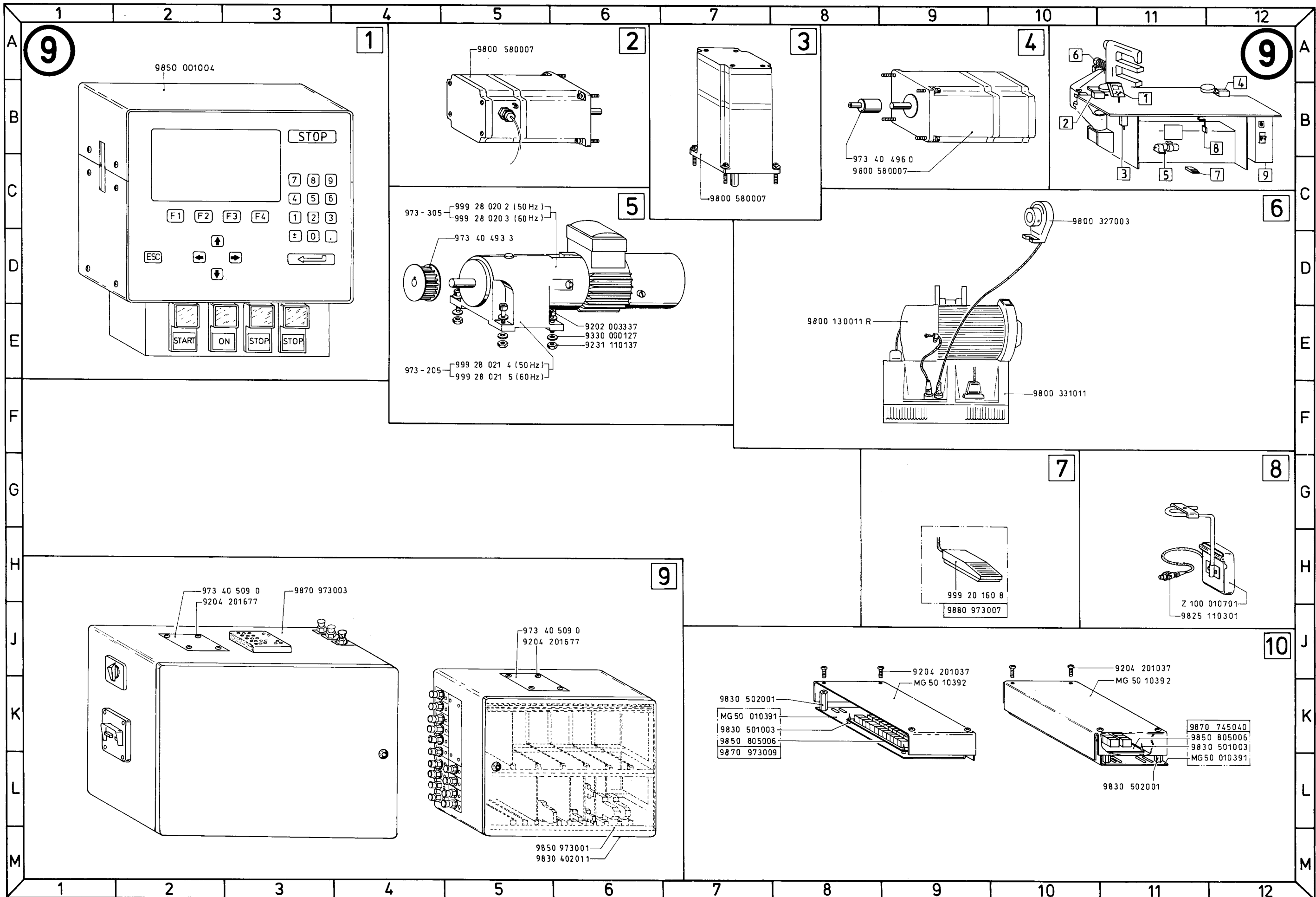

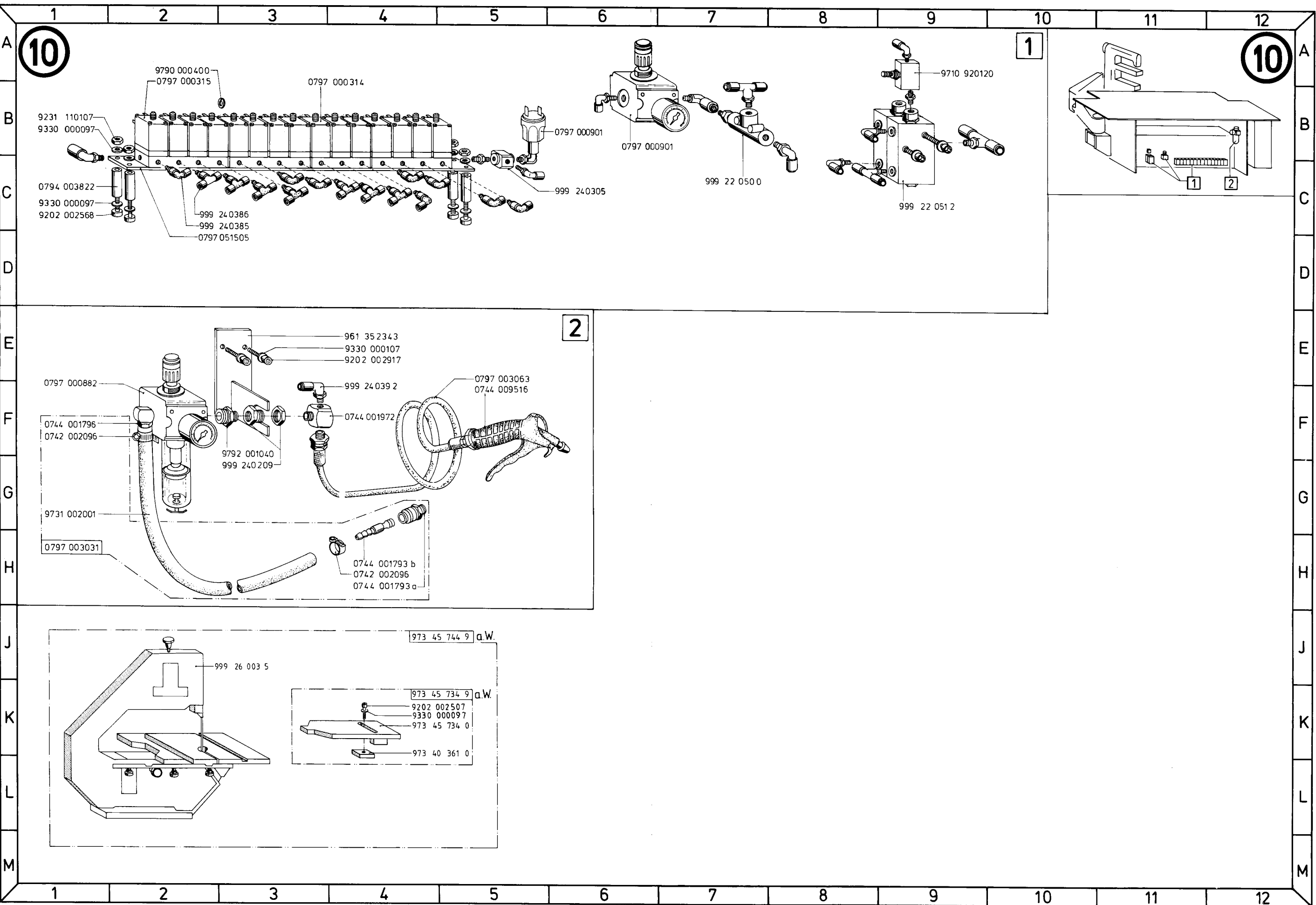

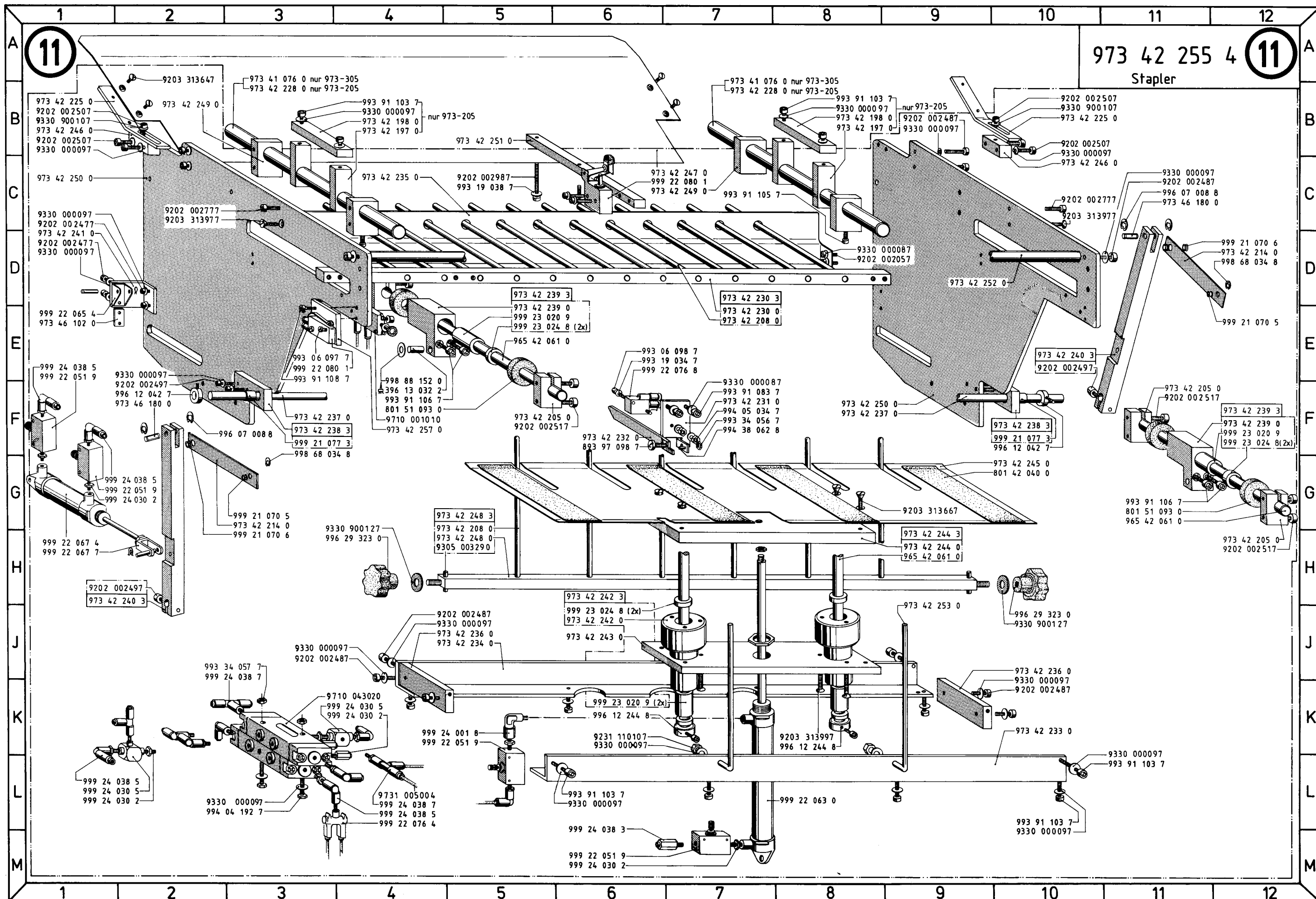

973 42 255 4 (11)
Stapler

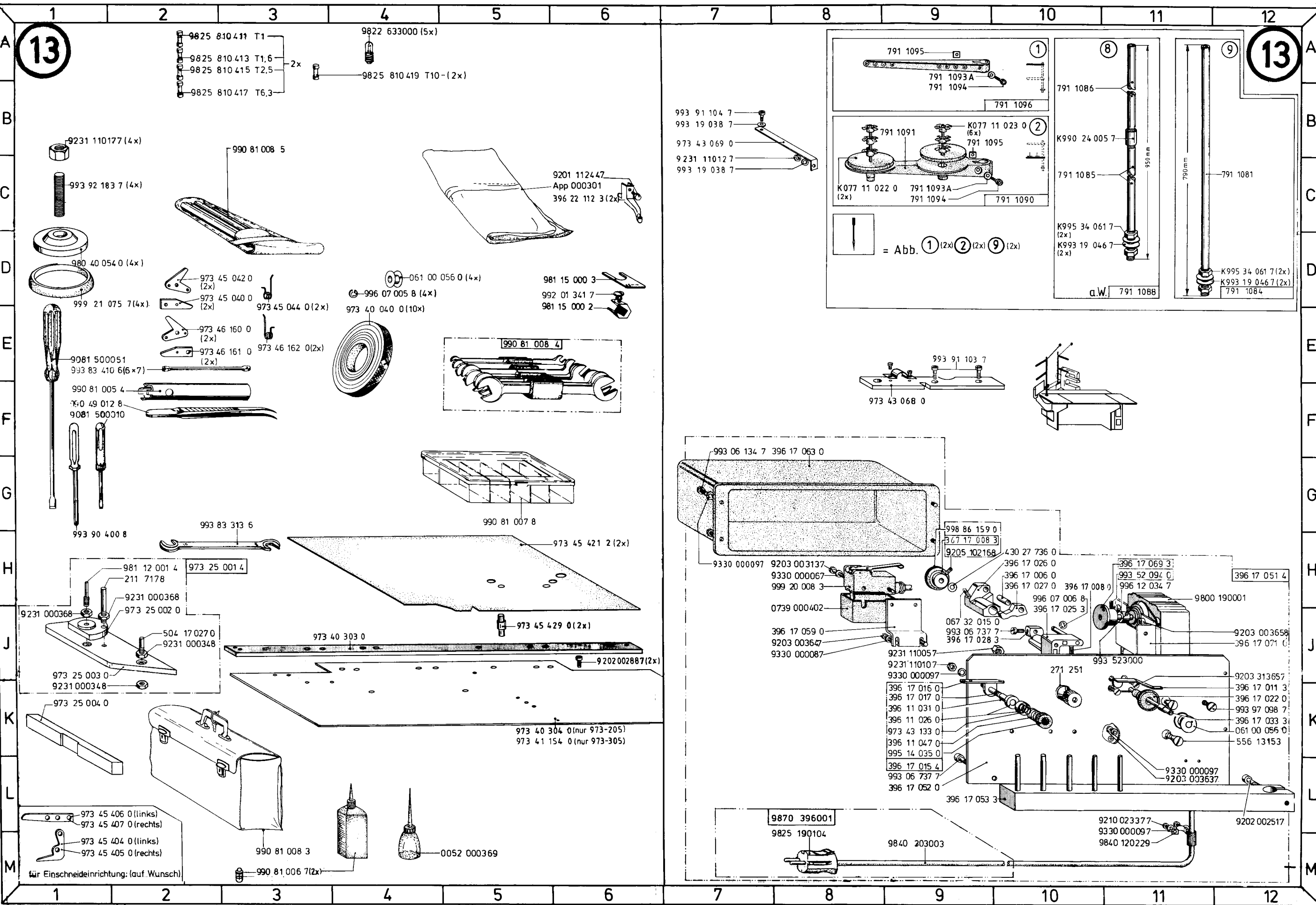

Teile-Nr.	Benennung	Bildtafel	Teile-Nr.	Benennung	Bildtafel
K1.973			K196 00 049 0	NADELLAGER NEEDLE BEARING	1D4
K006 00 416 0	BLATTFEDER LEAF SPRING	7.2E7	K196 00 112 0	VERSCHL-STOPFEN	1C3
K016 00 255 0	SCHEIBE DISC	1D8	K196 00 115 0	FADENANZUGFEDER TENSION SPRING	1K2
K030 00 134 0	FEDER SPRING	1A2	K196 00 169 0	SCHEIBE DISC	1L6
K037 00 129 0	SPANNUNGSFEDER TENSION SPRING	1L2	K196 00 170 0	ANSCHLAG GUIDE	1H4
K053 00 035 0	SCHEIBE DISC	1H10	K196 00 186 0	BUCHSE BUSHING	1J7
K061 00 056 0	SPULE BOBBIN	1L5 13D4	K196 00 187 0	ROEHRCHEN PIPE	1J7
K067 23 305 0	DRUCKFEDER PRESSURE SPRING	1L8	K196 00 188 0	DICHTSCHEIBE GASKET	1K6
K067 32 015 0	DRUCKFEDER PRESSURE SPRING	13J9	K196 00 189 0	DRUCKFEDER PRESSURE SPRING	7H3 7H11 7L5 7L8
K077 11 022 0	AUFLAGE SUPPORT	13C8	K196 00 198 3	STIRNRAD WHEEL	1M8
K077 11 023 0	ZENTRIERSTUECK CENTERING PIECE	13B9	K196 00 199 3	STIRNRAD WHEEL	1K7
K091 00 214 0	ZAHNRIEMEN BELT V 537/ 7-F	1K11	K296 00 007 0	GEHAEUSE HOUSING	1D6
K096 14 195 3	STELLRING ADJ RING	1L11	K296 00 008 0	RING RING	1D10 1E6
K096 15 241 3	SCHARNIER	1K3	K296 00 009 0	GEHAEUSE HOUSING	1D6
K097 00 335 0	SCHRAUBE SCREW	1B5	K296 00 012 0	GEHAEUSE HOUSING	1D10
K098 00 299 0	DRUCKFEDER PRESSURE SPRING	1B4	K296 00 014 0	HUELSE BUSH	1D11
K105 31 014 3	STELLRING ADJ RING	4E4 7.3M9	K296 00 018 0	REGULIERSTUECK REGULAT PIECE	1H7
K196 00 019 0	VERSCHL SCHRIB SCREW	1C3	K296 00 033 0	OELDOCHT OIL WICK	1B4
K196 00 027 0	HUELSE BUSH	1L2	K296 00 041 0	GLEITSTEIN SLIDE STONE	1E4
K196 00 029 0	SPANNBUCHSE TENSION BUSHING	1K2	K296 00 045 3	KURBEL CRANK	1B4
K196 00 042 3	KLOBEN BLOCK	1E3	K296 00 048 0	ANLAUFSCHIEBE DISC	1D4
K196 00 043 3	GELENK JOINT	1D4	K296 00 050 0	DOCHT WICK 0,270 LG.	1C2
K196 00 044 0	BUCHSE BUSHING	1E3	K296 00 101 0	OELDOCHT OIL WICK	1C5
K196 00 047 0	FEDER SPRING	1O2	K296 00 114 0	RING RING	1C10

Teile-Nr.	Benennung	Bildtafel	Teile-Nr.	Benennung	Bildtafel
K296 00 116 0	NIPPEL NIPPLE	1D9	K296 31 086 3	ZUGSTANGE PULL ROD	1B8
K296 00 117 0	NIPPEL NIPPLE	1D9	K296 31 098 0	STOPFEN PLUG	1F6
K296 00 118 0	HOHLSCHRAUBE HOLLOW SCREW	1E10	K296 33 003 3	HUBEXZENTER STROKECAM	1D7
K296 00 120 0	SCHEIBE DISC	1E10	K296 33 003 4	HUBEXZENTER STROKECAM	1D7
K296 00 125 0	DICHTSCHEIBE GASKET	1B10	K296 35 029 0	BUCHSE BUSHING	1B1
K296 00 131 0	OELEINF.SCHR.	1B10	K367 17 008 3	SPULERRAD WINDER WHEEL	13H9
K296 00 131 3	OELSCHRAUBE OIL SCREW	1B10			
K296 00 132 0	OEL-SCHAUGLAS	1B10			
K296 00 136 0	OELROHR OIL PIPE	1C10			
K296 00 144 0	NIPPEL NIPPLE	1L8 1L9	K381 10 041 0	OELSTANDSAUGE OIL SIGHT GLASS	1J8
K296 00 208 3	LAGER BEARING	1J10	K381 10 042 0	DICHTUNGSRING	1J8
K296 00 209 0	ACHSE AXLE	1G10	K381 10 043 0	ABLASSSCHRAUBE DRAIN SCREW	1J6
K296 00 210 0	SPANNROLLE CLAMPING ROLLER	1H10	K381 11 004 3	RAENDELMUTTER KNURLED NUT	1L2
K296 00 210 4	SPANNROLLE CLAMPING ROLLER	1J11			
K296 00 211 3	ZAHNRIEMENRAD BELT PULLEY	1M11	K396 10 003 0	DICHTUNG GASKET	1F5
K296 00 212 3	ZAHNRIEMENRAD BELT PULLEY	1D10	K396 10 048 3	VERSCHL SCHEIBE DISC	1C11
K296 10 011 3	STIFT PIN	1C8	K396 10 051 0	FADENHEB SCHUTZ PROTECTOR	1E7
K296 10 012 0	STUETZE SUPPORT	1D9	K396 10 053 0	HALTEBLECH HOLDING PLATE	1F6
K296 13 011 0	FUEHRUNGSSTUECK GUIDE PIECE	1E2	K396 10 055 0	LAGERGEHAEUSE	1D10
K296 15 001 0	LAGER BEARING	1G10	K396 10 055 4	GEHAEUSE HOUSING	1D10
K296 15 001 3	LAGER V	1G10	K396 10 078 0	DRUCKFEDER PRESSURE SPRING D=0,37 DIN 2076 C	1E9
K296 15 002 0	GREIFERWELLE		K396 10 088 0	FINGERSCHUTZ FINGER GUARD	1E7
K296 15 002 3	GREIFERWELLE HOOK SHAFT	1L7	K396 10 091 3	VENTILGEHAEUSE VALVE CASE	1C6
K296 15 003 0	RING RING	1L7	K396 10 091 4	VENTILGEHAEUSE VALVE CASE	1C6
K296 15 004 0	BUCHSE BUSHING	1K7	K396 10 094 0	SCHRAUBE SCREW	1C5
K296 16 012 0	STOPFEN PLUG	1J6	K396 10 096 0	ANSATZBUCHSE	1F5
			K396 10 103 0	LEITBLECH GUIDE PLATE	1E2
K296 31 071 0	BUCHSE BUSHING	1D1	K396 10 117 0	SCHUTZGEHAEUSE	1D6
K296 31 080 0	KLOBEN BLOCK	1D2	K396 10 312 0	ARMWELLE ARM SHAFT	1D8
K296 31 085 0	BOLZEN BOLT	1E1	K396 10 332 4	ARMWELLE ARM SHAFT	1D8
			K396 10 346 0	GEGENGEWICHT	1D8

Teile-Nr.	Benennung	Bildtafel	Teile-Nr.	Benennung	Bildtafel
K396 10 501 0	ARM ARM GMGAL9ZN1H	1G10			
K396 10 502 0	UNTERARM	1J8			
K396 10 504 0	ARMDECKEL ARM COVER	1E8			
K396 10 506 0	DECKEL COVER	1H8			
K396 10 507 0	DICHTUNG GASKET	1H8			
K396 10 508 0	ANTRIEBSWELLE DRIVING SHAFT	1M7			
K396 10 509 3	KLAUE CLAW	1L10			
K396 10 510 0	WELLE SHAFT	1M12			
K396 10 512 0	ZAHNRAD COG WHEEL	1M10 4D2 7.3C2 7.3L10			
K396 10 513 4	LAGERBOCK PILLOW BLOCK	1B8			
K396 10 514 3	KRONRAD V	1D7			
			K396 11 164 4	FADENSCHNITT THREAD TENSION	1G7 1K2
			K396 12 024 0	FUEHRUNG GUIDE	1E4
			K396 12 028 3	FADENHEBEL THREADLEVER	1D4
			K396 12 037 0	BUCHSE BUSHING	1C3
			K396 12 039 0	BUCHSE BUSHING	1C3
			K396 12 064 3	BUCHSE BUSHING	1E3
			K396 12 099 3	NADELSTANGE NEEDLE BAR	1F3
			K396 12 109 3	KURBEL CRANK	1D3
			K396 12 110 4	ARMWELLENKURBEL	1D4
			K396 13 032 2	SCHALTBOLZEN	11F4
			K396 13 073 0	GEWINDEBUCHSE	1C1
			K396 13 074 0	GEWINDEHUELSE	1C1
			K396 13 075 0	REGULIERSCHR.	1B1
			K396 13 076 0	KONTERMUTTER	1B1
			K396 14 005 0	DICHTSCHEIBE GASKET	1G8
			K396 15 004 0	SCHRAUBE SCREW	1J8
			K396 15 007 3	KAPPE CAP	1K6
			K396 15 008 0	SCHEIBE DISC	1K6
			K396 15 009 3	SCHWINGE OSCILLATOR	1J6
			K396 15 010 3	GELENK JOINT	1H4
K396 10 519 0	ANTRIEBSRAD DRIVING WHEEL	1C7			
K396 10 527 0	GRIFF GRIP	1A6			
K396 10 528 0	SCHEIBE DISC	1A6			
K396 10 529 0	FEDER SPRING	1B7			
K396 10 537 4	OELFALLROHR	1E10			
K396 10 539 4	HANDRAD HANDWHEEL	1B11			
K396 11 001 0	BOLZEN BOLT	1K2			
K396 11 002 0	FADENLEITSTIFT GUIDE PIN	1B8			
K396 11 026 0	SPANNBUCHSE TENSION BUSHING	13K9			
K396 11 031 0	BUCHSE BUSHING	13K9			
K396 11 032 0	FADENOESE THREAD LOOP	1E3			
K396 11 035 0	KLEMMSTUECK CLAMP PIECE	1G6			
K396 11 036 0	FADENFUEHRUNG THREAD GUIDE	1F7			
K396 11 047 0	DRUCKFEDER PRESSURE SPRING	13K9			

Teile-Nr.	Benennung	Bildtafel	Teile-Nr.	Benennung	Bildtafel
K396 15 011 0	LUEFTER KPL LIFTER CPL	1J4	K396 17 008 0	DRUCKFEDER PRESSURE SPRING	13H10
K396 15 013 0	ANSATZBOLZEN SHOULDER BOLT	1J6	K396 17 011 3	AUSLOESEHEBEL RELEASE LEVER	13K12
K396 15 020 0	ABWEISBLECH DEFLECT PLATE	1J5	K396 17 015 4	SPANNUNG TENSION	13L9
K396 15 021 0	EXZENTERBUCHSE ECCENTR BUSH	1J5	K396 17 016 0	FADENFUEHRUNG THREAD GUIDE	13K9
K396 15 033 0	DECKBLECH COVER PLATE	1L8	K396 17 017 0	GEWINDEBOLZEN THREADED BOLT	13K9
K396 15 034 0	EXZENTERRING ECCENTR RING	1M9	K396 17 022 0	BUCHSE BUSHING	13K12
K396 15 034 4	EXZENTERRING ECCENTR RING	1M9	K396 17 025 3	SPULERBOCK WINDER BLOCK	13J10
K396 15 038 0	GEW.-HUELSE	1K8	K396 17 026 0	ARM ARM	13H10
K396 15 039 3	KAPPE CAP	1G4	K396 17 027 0	KLOBEN BLOCK	13H10
K396 15 041 0	WELLE SHAFT	1G4	K396 17 028 3	NOCKEN CAM	13J9
K396 15 042 4	KAPPE KPL CAP CPL KPL.	1G4	K396 17 033 3	SPULERWELLE WINDER SHAFT	13K12
K396 15 067 0	OELROHR OIL PIPE	1H7	K396 17 051 4	SPULER BOBBIN WINDER	13H12
K396 15 067 3	OELROHR OIL PIPE	1H7	K396 17 052 0	PLATTE PLATE	13L9
K396 15 068 4	VERTEILER	1K9	K396 17 053 3	HALTER HOLDER	13L9
K396 15 079 0	FADENFUEHRUNG THREAD GUIDE	1K3	K396 17 059 0	HALTER HOLDER	13J8
K396 15 080 0	SCHRAUBE SCREW	1K3 3L3	K396 17 063 0	HAUBE COVER	13F8
K396 15 082 4	SPULENGEHAEUSE BOBBIN CASE	1M3			
K396 15 085 0	BREMSFEDER BRAKE SPRING	1K3	K396 17 069 3	RAD WHEEL	13H11
K396 15 086 0	SENKSCHRAUBE SCREW	3L3			
K396 15 087 0	GEWINDESTIFT THREADED PIN M 1,8 X 2	1L3	K396 20 023 3	STICHPLATTE THROAT PLATE	1F11
K396 15 088 0	STIFT PIN 13/8 X 35	3L3	K396 20 088 3	STICHPLATTE THROAT PLATE	1G11
K396 15 091 4	GREIFER HOOK	1L5 1M4	K396 22 112 3	FUSS FOOT	1F11 13C6
K396 15 094 0	HALTER	1J4			
K396 15 095 0	NADELSCHUTZ	1J5	K396 31 003 0	SCHEIBE DISC	1B8
K396 15 095 4	NADELSCHUTZ	1K4	K396 31 011 0	STIFT PIN	1D1
K396 15 096 0	ROLLE	1J4	K396 31 016 0	BUCHSE BUSHING	1E1
K396 16 008 3	KURBEL CRANK	1H5	K396 31 022 0	RING RING	1D1
K396 16 038 0	BUCHSE BUSHING	1M6			
K396 17 006 0	HUELSE BUSH	13H10			

Teile-Nr.	Benennung	Bildtafel	Teile-Nr.	Benennung	Bildtafel
K396 31 026 0	DRUCKFEDER PRESSURE SPRING 1,0 C DIN 2076 C	1C2	K699 97 911 3	SCHLAUCH 13 LMX 2 PVAL	7F2 7D10
K396 31 038 3	KLOBEN BLOCK	1E1			
K396 31 039 0	STOFFDR STANGE FOOT BAR	1E1			
K396 31 057 3	ZUGSTANGE PULL ROD	1D8			
K396 31 131 0	ZUGSTANGE PULL ROD	1E1	K699 98 922 0	PL.GUMMI	7.4B1 7.4B6 7.4K2
K396 31 132 0	WINKELHEBEL LEVER	1D1	K699 98 926 1	PL.MOOSGUMMI 3	7.1B2 7.1B7 7.1F2 7.1F7 7.1J2 7.1J7
K396 31 132 4	WINKELHEBEL LEVER	1E1	K699 99 158 2	PFEIFENREINIGER	1C8
K396 33 105 3	GEHAEUSE HOUSING	1D7	K699 99 158 5	OELDOCHT RD4	1E6
K396 34 255 0	EINSTELLKNOPF	1A2			
K396 34 258 0	DREHFEDER SPRING	1A2			
K396 34 306 0	BUNDBUCHSE	1A2	K801 42 040 0	GUMMIMATTE RUBBER MAT	5G9 11G10
K396 34 307 3	STELLSCHEIBE ADJ DISC	1B2			
K396 34 308 4	LAGERBOCK PILLOW BLOCK	1B4			
K396 34 311 0	DISTANZSCHEIBE DISTANCE DISC	1C2	K801 51 093 0	DAEMPFUNGSRING ABSORBERRING	11F4 11G11
K396 34 312 0	EXZENTERBÖLZEN ECCENTR BOLT	1B4			
K396 34 315 0	BÖLZEN BOLT	1B4	K802 51 006 0	GELENK JOINT	8.1D8 8.1E4
K396 35 066 0	HUELSE BUSH	1A6	K802 51 045 0	STELLSCHRAUBE SCREW	2E8 2K7 2K10 2K11
K430 27 736 0	SCHEIBE DISC	13H10	K802 51 063 0	GEWINDEPLATTE THREADED PLATE	5C2 7.3M11
K467 11 022 0	SPANNSCHEIBE TENSION WASHER	1L1	K802 51 169 0	BUCHSE BUSHING	1A2
K568 10 008 0	HANDRAD HANDWHEEL KUNSTSTOFF	1B11	K821 45 064 0	STANGE ROD	3D8
K568 15 019 3	EXZENTER ECCENTRIC	1M9	K893 06 673 7	SCHRAUBE SCREW M3X5	1J4 1J5
K568 15 020 0	KLOBEN BLOCK	1L9			
K568 34 009 0	SCHEIBE DISC	1A3	K893 06 716 7	SCHRAUBE SCREW M4X10 9 S MN 28 K	1J4
K568 34 050 3	LAGERBOCK PILLOW BLOCK	1B2	K893 06 734 7	SCHRAUBE SCREW M5X 6	1H4
K568 34 053 0	BUCHSE BUSHING	1B2			
K568 34 054 0	PISTON PISTON	1A2			
K699 97 910 0	SCHLAUCH 2,5LWX1 PVC RAU	1B9 1K8 1K10 1L9	K893 23 045 8	FEDERSCHEIBE SPRING DISC A4	8E3 8F9

Teile-Nr.	Benennung	Bildtafel	Teile-Nr.	Benennung	Bildtafel
			K971 10 006 0	HOHLSCHRAUBE HOLLOW SCREW	1F10
			K971 10 008 0	NIPPEL NIPPLE	1E7
			K971 14 024 3	ROHR PIPE	1H7
K893 23 049 8	FEDERSCHEIBE SPRING DISC A8	1G4	K971 15 002 3	BUCHSE BUSHING	1M10
K893 33 081 0	GEWINDESTIFT THREADED PIN M4X4	6C2	K971 43 027 0	ACHSE AXLE	2F11
K893 52 114 0	GEWINDESTIFT THREADED PIN M6X5	4E4 7.3M9	K971 43 028 0	ACHSE AXLE	2G6
			K971 43 036 0	SCHEIBE DISC	2D11 2E6 2G11 2H6 2H11
			K971 43 037 0	HUELSE BUSH	2E11 2F6
K893 97 098 7	SCHRAUBE SCREW M4X8	11F6	K971 45 132 2	PLATTE PLATE	7.1C7 7.1D2 7.1F7 7.1G2 7.1K2 7.1K7
K893 99 149 0	SCHRAUBE SCREW M4X5	4F11 5B2 7.3K11	K973 01 004 3	TISCHPLATTE TABLE TOP	3B4
			K973 01 008 3	TISCHPLATTE TABLE TOP	3B10
				PLATE	
			K973 01 010 3	TISCHPLATTE 500X500X40	3B11
			K973 40 002 3	SAEULE POST	2E6
K894 45 040 8	FAECHERSCHEIBE DISC A8,4	4J6 4K10	K973 40 040 0	BAND TAPE	7C3 13E4
			K973 40 043 0	SCHWENKARM PIVOT ARM	2C6
			K973 40 044 0	SCHWENKARMLAGER	2H9
K895 36 096 0	ZYL.STIFT CYLIND PIN 3 M6X10	1H6	K973 40 135 0	ANSATZBOLZEN SHOULDER BOLT	2K11
K895 36 117 0	ZYL STIFT CYLIND PIN 4 M6X12	1D7	K973 40 167 3	LAGERBOCK PILLOW BLOCK	5C5 5C8
K895 36 158 0	ZYL STIFT CYLIND PIN 6 M6X14	2K6 8G3 8H9	K973 40 168 0	LAGERBOCK PILLOW BLOCK	5C7
K907 02 008 3	SCHUBKASTEN DRAWER	3C2	K973 40 169 0	STANGE ROD	5C7
K907 02 009 0	FUEHRUNGSLEISTE GUIDE BAR	3C2 3D1 12G4	K973 40 171 0	STELLSCHRAUBE SCREW	3F4
			K973 40 184 0	BUCHSE BUSHING	3D11 3E4
			K973 40 205 0	PLATTE PLATE	2A6
K965 42 061 0	WELLE SHAFT	11E5 11G11 11H9	K973 40 228 0	LAGERBOCK PILLOW BLOCK	4J6 4K8
K965 51 115 0	BOLZEN BOLT	5L4 5L8	K973 40 229 0	STEUERSCHIENE	4C5
K971 10 004 0	OELSCHLAUCH OIL HOSE	1E8	K973 40 230 0	ZAHNSTANGE ROD	4D5
			K973 40 242 0	HEBEL LEVER	2K3

Teile-Nr.	Benennung	Bildtafel	Teile-Nr.	Benennung	Bildtafel
K973 40 245 0	GURTRAD BELT PULLEY	2J2	K973 40 303 0	EINSTELLEHRE GAUGE	13J4
K973 40 246 0	PLATTE PLATE	2K2	K973 40 304 0	PLATTE PLATE	13K5
K973 40 247 0	STIRNRAD WHEEL	2E1	K973 40 315 0	ZUGSTANGE PULL ROD	2K9
K973 40 250 0	STANGE ROD	4B4	K973 40 316 0	ZUGSTANGE PULL ROD	2H10
K973 40 253 3	ZAHNRIEMENRAD BELT PULLEY	4E1 4F8	K973 40 317 0	ZUGFEDER SPRING	3J6
K973 40 256 0	ROLLE ROLLER	2D1	K973 40 324 0	ABDECKUNG COVER	5A1
K973 40 259 0	DISTANZRING DISTANCE RING	2H2	K973 40 327 0	WELLE SHAFT	3K8
K973 40 260 0	SPANNPLATTE CLAMPING PLATE	4F4 4F7	K973 40 328 3	KLAUE CLAW	4D2
K973 40 264 0	FLANSCH FLANGE	4D6 4D8	K973 40 329 0	KLEMMSTUECK CLAMP PIECE	4E10
K973 40 267 0	KLOBEN BLOCK	4E5	K973 40 335 0	WINKEL ANGLE	4D3
K973 40 270 0	SPINDEL SPINDLE	4D3 5A3	K973 40 336 0	SCHIEBER SLIDE	4C3
K973 40 271 0	STEUERKURVE ZE	3E6	K973 40 345 0	WINKEL ANGLE	4E5
K973 40 272 0	BOLZEN BOLT	4J7 4K4	K973 40 350 0	DISTANZBLECH DISTANCE PLATE	4B2 4B7
K973 40 273 0	BOLZEN BOLT	3J6	K973 40 351 0	MAGAZIN	3K1
K973 40 274 0	HEBEL LEVER	3K8	K973 40 352 0	LAGERBOCK LI.	4F3
K973 40 275 0	WINKEL ANGLE	3H8	K973 40 353 0	LAGERBOCK RE.	4F6
K973 40 277 0	SCHALTERTRAEGER SWITCH SUPPORT	3G8	K973 40 354 0	LASCHE SHACKLE	3H10
K973 40 278 0	SCHALTERTRAEGER SWITCH SUPPORT	5C8	K973 40 357 0	SPINDEL SPINDLE	4G5
K973 40 279 0	FUEHRUNG GUIDE	5C5	K973 40 358 0	BOLZEN BOLT	2L3
K973 40 284 3	LAGERBOCK PILLOW BLOCK	3E3	K973 40 359 0	RIEMENSCHUTZ BELT GUARD	2L5
K973 40 287 3	WINKELHEBEL LEVER	2J10	K973 40 360 0	DAEMMPLATTE	2H5
K973 40 289 0	GELENK JOINT	3E1	K973 40 366 3	RAHMEN FRAME	4G5
K973 40 292 0	STUETZE SUPPORT	4B5	K973 40 382 0	WELLE SHAFT	4F3 4F6
K973 40 293 0	VERSTAERKUNG	4B5	K973 40 383 0	LAGER BEARING	4E9
K973 40 294 3	ZAHNRIEMENRAD BELT PULLEY	4H6 4J7			
K973 40 295 0	GABEL FORK	4J6 4J8			
K973 40 296 0	ROLLE ROLLER	3H8			
K973 40 298 0	VERSTAERKUNG	4D5			
K973 40 301 0	HEBEL LEVER	3F6 3F11			

Teile-Nr.	Benennung	Bildtafel	Teile-Nr.	Benennung	Bildtafel
			K973 40 446 0	HEBEL LEVER	2J6
K973 40 392 0	BRUECKE BRIDGE	7K6	K973 40 447 0	KLOBEN BLOCK	3H9
K973 40 394 0	ABDECKUNG COVER	4A8	K973 40 448 0	FUEHRUNG GUIDE	7J5 7J9
K973 40 396 0	WINKEL ANGLE	3D7 3D8	K973 40 449 0	ABDECKUNG COVER	5G3
K973 40 402 3	GESTELL	3L4	K973 40 454 0	FEDER SPRING	4C4
			K973 40 455 0	LEISTE REGLET	4F8
			K973 40 456 0	WINKEL ANGLE	4H7
K973 40 415 0	WINKEL ANGLE	3L8			
K973 40 416 0	ARBEITSPLATTE WORKING PLATE	5F3	K973 40 461 0	PLATTE PLATE	8A5 889
K973 40 418 0	VERBINDUNG CONNECTION	5K7			
K973 40 419 0	SCHIEBER SLIDE	5F3			
K973 40 420 0	ABDECKUNG	5G3			
K973 40 421 0	LEISTE REGLET	5G9	K973 40 465 0	ABDECKUNG COVER	3G8
K973 40 422 0	BOLZEN BOLT	5L6 5L11			
K973 40 423 0	ANSATZSCHEIBE	5H5	K973 40 473 0	SCHEIBE	3D5 3D11 3E10
K973 40 424 0	ZUGFEDER SPRING	5G9	K973 40 475 3	BUCHSE	4E3
K973 40 427 0	LAGERBOCK PILLOW BLOCK	7.3M12	K973 40 480 0	RING	4E6 4E8
K973 40 428 0	WINKEL ANGLE	7.3M10	K973 41 004 0	DISTANZSTUECK,1 14.50Z	7.4H6
K973 40 429 0	PLATTE PLATE	5C2	K973 41 005 0	DISTANZSTUECK,1 15.00Z	7.4H6
K973 40 430 0	HEBEL LEVER	5B2 7.3M11	K973 41 006 0	DISTANZSTUECK,1 15.50Z	7.4H6
K973 40 431 0	BUCHSE BUSHING	4E6 7.3L5	K973 41 007 0	DISTANZSTUECK,1 16.00Z	7.4H6
K973 40 432 0	DRUCKFEDER PRESSURE SPRING	4E6 7.3L5	K973 41 008 0	DISTANZSTUECK,1 16.50Z	7.4H6
K973 40 434 0	ABLAGEKASTEN	3H1	K973 41 009 0	DISTANZSTUECK,1 17.00Z	7.4H6
			K973 41 010 0	DISTANZSTUECK,1 17.50Z	7.4J6
			K973 41 011 0	DISTANZSTUECK,1 18.00Z	7.4J6
K973 40 440 0	ZAHNRAD COG WHEEL	4E10	K973 41 012 0	DISTANZSTUECK,1 18.50Z	7.4J6
			K973 41 013 0	DISTANZSTUECK,1 19.00Z	7.4J6
			K973 41 014 0	DISTANZSTUECK,1 10	7.4K6

Teile-Nr.	Benennung	Bildtafel	Teile-Nr.	Benennung	Bildtafel
K973 41 015 0	DISTANZSTUECK DISTANCE PIECE 20	7.4K6	K973 41 066 0	U SCHIENE RAIL	7.3J7
K973 41 016 0	DISTANZSTUECK DISTANCE PIECE 30	7.4K6	K973 41 072 3	GURTRAD BELT PULLEY	7.3K10
K973 41 017 0	DISTANZSTUECK DISTANCE PIECE 40	7.4L6	K973 41 073 3	ROLLE ROLLER	7.3H9
K973 41 018 0	DISTANZSTUECK DISTANCE PIECE 50	7.4L6	K973 41 074 3	GURTRAD BELT PULLEY	7.3B4 7.3H11
K973 41 019 0	DISTANZSTUECK DISTANCE PIECE 60	7.4L6	K973 41 075 3	KLOBEN BLOCK	7.3A2 7.3H10
K973 41 020 0	DISTANZSTUECK DISTANCE PIECE 70	7.4L6	K973 41 076 0	WELLE SHAFT	11A3 11A7 7.3M5 7.3M9
K973 41 021 0	DISTANZSTUECK DISTANCE PIECE 80	7.4L6	K973 41 077 0	PLATTE PLATE	7.3L5
K973 41 022 0	DISTANZSTUECK DISTANCE PIECE 90	7.4L6	K973 41 078 0	WELLE SHAFT	7.3L10
K973 41 023 0	DISTANZSTUECK 100	7.4L6	K973 41 079 3	AUFNAHME RECEPTION	7F8 7.4C10
K973 41 024 0	DISTANZSTUECK 110	7.4M6	K973 41 080 0	FEDER SPRING RE.	7.4C5
K973 41 025 0	DISTANZSTUECK 120	7.4M6	K973 41 081 0	FEDER SPRING LI.	7.4C3
K973 41 026 0	DISTANZSTUECK 130	7.4M6	K973 41 084 0	KLAMMERPLATTE CLAMPING PLATE	7.4B6
K973 41 054 0	LAGERPLATTE BEARING PLATE	7.3K10	K973 41 085 0	KLAMMERPLATTE CLAMPING PLATE	7.4B1
K973 41 055 0	BOLZEN BOLT	7.3H10 7.3K10	K973 41 089 0	ABDECKUNG RE.	7.3J5
K973 41 056 0	PLATTE PLATE	7.3L9	K973 41 091 0	ABDECKUNG COVER	7.3J5
K973 41 057 0	LAGERBOCK PILLOW BLOCK	7.3L10	K973 41 093 4	DISTANZSTUECK DISTANCE PIECE ZOLL	7.4G4 7.4G6
K973 41 058 0	LAGERBOCK PILLOW BLOCK	7.3K5	K973 41 094 4	DISTANZSTUECK DISTANCE PIECE MM	7.4H4 7.4J6
K973 41 059 0	KLOBEN BLOCK	7.3K7	K973 41 095 3	DISTANZPLATTE DISTANCE PLATE 14.00Z	7.4H7
K973 41 060 0	LAGERPLATTE BEARING PLATE	7.3B1	K973 41 096 3	DISTANZPLATTE DISTANCE PLATE 14.50Z	7.4H7
K973 41 061 0	WELLE SHAFT	7.3B4 7.3K7 7.3M12	K973 41 097 3	DISTANZPLATTE DISTANCE PLATE 15.00Z	7.4H7
K973 41 062 0	DISTANZBUCHSE DISTANCE BUSH	7.3B4 7.3L12	K973 41 098 3	DISTANZPLATTE DISTANCE PLATE 15.50Z	7.4H7
K973 41 063 0	LEISTE REGLET	7.3L10	K973 41 099 3	DISTANZPLATTE DISTANCE PLATE 16.00Z	7.4H7
K973 41 064 0	LEISTE REGLET	7.3J7	K973 41 100 3	DISTANZPLATTE DISTANCE PLATE 16.50Z	7.4H7
K973 41 065 3	MUTTER NUT	7.3L9			

Teile-Nr.	Benennung	Bildtafel	Teile-Nr.	Benennung	Bildtafel
K973 41 101 3	DISTANZPLATTE DISTANCE PLATE 17.00Z	7.4H7	K973 41 121 0	BUCHSE BUSHING	7.3K5 7.3K6
K973 41 102 3	DISTANZPLATTE DISTANCE PLATE 17.50Z	7.4J7	K973 41 122 0	FEDER SPRING	7.4B1
K973 41 103 3	DISTANZPLATTE DISTANCE PLATE 18.00Z	7.4J7	K973 41 124 0	ABDECKUNG	4A8
K973 41 104 3	DISTANZPLATTE DISTANCE PLATE 18.50Z	7.4J7	K973 41 128 0	SCHEIBE DISC	7.3H10 7.3K9 7.3K10
K973 41 105 3	DISTANZPLATTE DISTANCE PLATE 19.00Z	7.4J7		973-TN-1,OHNE FORM	
K973 41 106 3	DISTANZPLATTE DISTANCE PLATE 10	7.4K7	K973 41 130 4	973-FN-1/NAEHGU 973-FN1,FORMFERTIG	7.4B8
K973 41 107 3	DISTANZPLATTE DISTANCE PLATE 20	7.4K7	K973 41 133 3	DISTANZPLATTE DISTANCE PLATE 14.25Z	7.4G10
K973 41 108 3	DISTANZPLATTE DISTANCE PLATE 30	7.4K7	K973 41 134 3	DISTANZPLATTE DISTANCE PLATE 14.25Z	7.4H10
K973 41 109 3	DISTANZPLATTE DISTANCE PLATE 40	7.4L7	K973 41 135 3	DISTANZPLATTE DISTANCE PLATE 15.75Z	7.4H10
K973 41 110 3	DISTANZPLATTE DISTANCE PLATE 50	7.4L7	K973 41 136 3	DISTANZPLATTE DISTANCE PLATE 15.75Z	7.4H10
K973 41 111 3	DISTANZPLATTE DISTANCE PLATE 60	7.4L7	K973 41 137 3	DISTANZPLATTE DISTANCE PLATE 15.25Z	7.4H10
K973 41 112 3	DISTANZPLATTE DISTANCE PLATE 70	7.4L7	K973 41 138 3	DISTANZPLATTE DISTANCE PLATE 15.75Z	7.4H10
K973 41 113 3	DISTANZPLATTE DISTANCE PLATE 80	7.4L7	K973 41 139 3	DISTANZPLATTE DISTANCE PLATE 17.25Z	7.4H10
K973 41 114 3	DISTANZPLATTE DISTANCE PLATE 90	7.4L7	K973 41 140 3	DISTANZPLATTE DISTANCE PLATE 17.75Z	7.4H10
K973 41 115 3	DISTANZPLATTE DISTANCE PLATE 100	7.4L7	K973 41 141 3	DISTANZPLATTE DISTANCE PLATE 18.25Z	7.4J10
K973 41 116 3	DISTANZPLATTE DISTANCE PLATE 110	7.4M7	K973 41 142 3	DISTANZPLATTE DISTANCE PLATE 18.75Z	7.4J10
K973 41 117 3	DISTANZPLATTE DISTANCE PLATE 120	7.4M7	K973 41 143 4	DISTANZSTUECK DISTANCE PIECE ZOLL	7.4G9 7.4H4
K973 41 118 3	DISTANZPLATTE DISTANCE PLATE 130	7.4M7	K973 41 144 0	DISTANZSTUECK DISTANCE PIECE 14.25Z	7.4G9
K973 41 119 0	WELLE SHAFT	7.3C1	K973 41 145 0	DISTANZSTUECK DISTANCE PIECE 14.75Z	7.4H9
K973 41 120 0	KLAUE CLAW	7.3B1 7.3C1 7.3M10	K973 41 146 0	DISTANZSTUECK DISTANCE PIECE 15.25Z	7.4H9
			K973 41 147 0	DISTANZSTUECK DISTANCE PIECE 15.75Z	7.4H9

Teile-Nr.	Benennung	Bildtafel	Teile-Nr.	Benennung	Bildtafel
K973 41 148 0	DISTANZSTUECK DISTANCE PIECE 16.25Z	7.4H9	K973 42 233 0	LEISTE REGLET	11K10
K973 41 149 0	DISTANZSTUECK DISTANCE PIECE 16.75Z	7.4H9	K973 42 234 0	LEISTE REGLET	11J5
K973 41 150 0	DISTANZSTUECK DISTANCE PIECE 17.25Z	7.4H9	K973 42 235 0	ABSTREIFBLECH STRIPPING PLATE	11C4
K973 41 151 0	DISTANZSTUECK DISTANCE PIECE 17.75Z	7.4H9	K973 42 236 0	FLANSCH FLANGE	11J5 11J10
K973 41 152 0	DISTANZSTUECK DISTANCE PIECE 18.75Z	7.4J9	K973 42 237 0	WELLE SHAFT	11F3 11F8
K973 41 153 0	DISTANZSTUECK DISTANCE PIECE 18.75Z	7.4J9	K973 42 238 3	LAGER BEARING	11F3 11F10
K973 41 154 0	PLATTE	13K5	K973 42 239 0	SCHLITTEN CARRIAGE	11E5 11F12
K973 41 157 2	AUFLAGE SUPPORT	7.4B1 7.4B6	K973 42 239 3	SCHLITTEN CARRIAGE	11D5 11F12
K973 41 158 2	AUFLAGE SUPPORT	7.4H2	K973 42 240 3	HEBEL	11E10 11H2
K973 41 159 2	AUFLAGE SUPPORT	7.4H2	K973 42 241 0	WINKEL ANGLE	11D1
K973 41 160 2	AUFLAGE SUPPORT	7.4H2	K973 42 242 0	FUEHRUNG GUIDE	11J6
K973 41 161 0	AUFLAGEBLECH SUPPORT PLATE	7.4C1	K973 42 242 3	FUEHRUNG GUIDE	11H6
K973 41 162 0	AUFLAGEPLATTE SUPPORT PLATE	7.4C6	K973 42 243 0	PLATTE PLATE	11J6
K973 41 163 0	ANSCHLAG GUIDE	7.3C3	K973 42 244 0	PLATTE PLATE	11H9
K973 42 197 0	BOCK SUPPORT	11B4 11B8	K973 42 244 3	PLATTE PLATE	11H9
K973 42 198 0	SPANNSTUECK TENSION PIECE	11B4 11B8	K973 42 245 0	AUFLAGE SUPPORT	11G10
K973 42 205 0	LAGER BEARING	11F5 11F11 11H12	K973 42 246 0	KLOBEN BLOCK	11B1 11C10
K973 42 208 0	STANGE ROD	11E7 11G5	K973 42 247 0	GLEITBLECH SLIDE PLATE	11C7
K973 42 214 0	ZUGSTANGE PULL ROD	11D12 11G3	K973 42 248 0	LEISTE REGLET	11H5
K973 42 225 0	WINKEL ANGLE	11B1 11B10	K973 42 248 3	LEISTE REGLET	11G5
K973 42 228 0	WELLE SHAFT	11B3 11B7	K973 42 249 0	LAGER BEARING	11B2 11C7
K973 42 230 0	LEISTE REGLET	11E7	K973 42 250 0	SEITENTEIL SIDE PART	11C1 11F8
K973 42 230 3	LEISTE REGLET	11D7	K973 42 251 0	LEISTE REGLET	4H7 11B5
K973 42 231 0	WINKEL ANGLE	11F7	K973 42 252 0	STANGE ROD	11D9
K973 42 232 0	HEBEL LEVER	11F6	K973 42 253 0	WINKEL ANGLE	11H9
			K973 42 255 4	STAPLER STACKER	11A11
			K973 42 257 0	PLATTE PLATE	11F4
			K973 43 068 0	STUETZE SUPPORT	2D5 13F9

Teile-Nr.	Benennung	Bildtafel	Teile-Nr.	Benennung	Bildtafel
K973 44 083 0	GABELKOPF FORK HEAD	8.1D8 8.1E3	K973 45 042 0	OBERMESSER UPPER KNIFE	7L3 13D3
K973 44 084 0	WINKEL ANGLE	8E11	K973 45 044 0	DREHFEDER SPRING	7L2 13E3
K973 44 085 0	WINKEL ANGLE	8E2	K973 45 048 0	LAGERBOCK PILLOW BLOCK	7H11 7J2
K973 44 086 0	FUEHRUNG GUIDE	8D10	K973 45 049 0	WELLE SHAFT	7J3 7J12
K973 44 087 0	SPINDEL SPINDLE	8C2 8D11	K973 45 050 3	TRANSPORTROLLE FEED ROLLER	7H11
K973 44 088 0	BOCK SUPPORT	8C2	K973 45 053 0	ROLLENHALTER REEL SUPPORT	7H3
K973 44 089 0	BLATTFEDER LEAF SPRING	8D10	K973 45 053 3	ROLLENHALTER REEL SUPPORT	7C1 7C11
			K973 45 055 0	DREHFEDER SPRING	7H2
			K973 45 056 0	DREHFEDER SPRING	7G10
			K973 45 203 0	KLEMMSTUECK CLAMP PIECE	7D9 7F8 7H9 7J4 7.1F12 7.1K11 7.4D10
K973 44 096 0	SPANNSTUECK TENSION PIECE	8H1 8H11 8.1F5 8.1F9	K973 45 225 0	BOLZEN BOLT	7G5 7G8
K973 44 097 0	BLATTFEDER LEAF SPRING	8J3 8J9	K973 45 227 0	BOLZEN BOLT	7E3 7F5
K973 44 098 0	WINKEL ANGLE	8D3 8D9 8J1 8J11	K973 45 228 0	BEFESTIGUNG KPL FASTENING CPL	7D4
K973 44 101 0	NUTMUTTER	8H1 8H11 12E6	K973 45 229 0	KLOBEN BLOCK	7E6 8B7
			K973 45 251 0	LASCHE SHACKLE	7D7 7G7 7K8 7L6
K973 44 111 0	LAGERBOCK RE.	8K10	K973 45 252 0	LASCHE SHACKLE	7H8 7L5 7L7
K973 44 112 0	LAGERBOCK LI.	8J3	K973 45 256 0	BOLZEN BOLT	7D7 7J7 7L5 7L6 7L7 7L8
K973 44 116 0	ANSCHL. RE.	8K11	K973 45 261 0	ROHR PIPE	7J10 7K2
K973 44 117 0	ANSCHL. LI.	8K3	K973 45 330 3	HEBEL LEVER	7G10 7H1
			K973 45 331 0	TRAEGER CARRIER	7F11 7G3
K973 44 753 4	SZ1-UE/.UMB.ES1 SZ1	8M1	K973 45 346 3	KLAMMERTRAEGER CLAMP CARRIER	7H4 7H9
K973 44 754 9	SZ2/SPITZENZANG SZ2	8M2	K973 45 347 0	KLAMMERPLATTE CLAMPING PLATE	7.1B5
			K973 45 348 0	AUFLAGEPLATTE SUPPORT PLATE	7.1D5 7.1L5
			K973 45 379 0	BOLZEN BOLT	8E3 8E9 8F3
			K973 45 380 3	KLEMMKLOBEN BLOCK	8D11 8E3 8F3 8F9
			K973 45 398 0	KLOBEN BLOCK	8F2 8F10
			K973 45 399 3	ZUGSTANGE PULL ROD	8E3 8E9
K973 45 040 0	UNTERMESSER LOWER KNIFE	7L3 13D3	K973 45 404 0	MESSER LI KNIFE LH	8F3 13M1

Teile-Nr.	Benennung	Bildtafel	Teile-Nr.	Benennung	Bildtafel
K973 45 405 0	MESSER RE KNIFE RH	8F9 13M1	K973 45 580 0	MESSERKLOBEN KNIFE SUPPORT	7M3 7M10
K973 45 406 0	MESSER LI KNIFE LH	8F3 13L1	K973 45 581 0	ZUGSTANGE PULL ROD	7L2 7L9
K973 45 407 0	MESSER RE KNIFE RH	8F9 13L1	K973 45 601 0	ROLLE ROLLER	8G3 8G9
K973 45 408 0	PLATTE PLATE	7G10 7H3	K973 45 679 0	SHELLE CLAMP	7J4 7J8
K973 45 413 3	KLAMMERPL SATZ CLAMP PLATE SET	7.1B8	K973 45 720 0	BOLZEN BOLT	7F7 7G6
K973 45 413 4	KLAMMERPL SATZ CLAMP PLATE SET HERRENKR.	7.1A8	K973 45 721 0	BOLZEN BOLT	7F5
K973 45 417 0	STANGE ROD	8D2 8E11	K973 45 722 0	STIRNPLATTE FRONT PLATE	7G6
K973 45 418 0	KAPPE CAP	7F11 7G1	K973 45 723 0	ZUGSTANGE PULL ROD	7F7
K973 45 421 2	SCHABLONE TEMPLATE	13H6			
K973 45 429 0	BOLZEN BOLT	13J5	K973 45 735 0	PLATTE PLATE	7J2 7J8
K973 45 445 3	KLAMMERTRAEGER CLAMP CARRIER	7D9 7F8 7.1F12 7.1K11 7.4D10	K973 45 737 0	BOLZEN BOLT	7D7 7.1G11 7.1K10
K973 45 452 0	ANSCHLAG GUIDE	8E3 8E9	K973 45 738 0	PLATTE PLATE	5C7
K973 45 536 0	HALTEPLATTE HOLDING PLATE	7J2 7J11	K973 45 740 0	KOERPER BODY	5B3 5B9
K973 45 558 0	LAGERBOCK PILLOW BLOCK	7H6	K973 45 741 0	SCHEIBE DISC	5C5
K973 45 559 0	GELENK JOINT	7F5			
K973 45 561 0	AUFNAHME RECEPTION	7G8	K973 45 745 3	AUFNAHME RECEPTION	7.1J9
K973 45 562 0	AUFNAHME RECEPTION	7C8 7.1F10	K973 45 745 9	ADAPTER KPL ADAPTER CPL F.STEBBUNDKRG.	7.1J12
K973 45 563 0	AUFNAHME RECEPTION	7C8 7.1E10	K973 45 746 0	KLAMMERPLATTE CLAMPING PLATE	7.1J5
K973 45 568 0	AUFLAGEPLATTE SUPPORT PLATE	7.1G5	K973 45 748 0	BOLZEN BOLT	7J7
K973 45 569 0	KLAMMERPLATTE CLAMPING PLATE	7.1E5	K973 45 749 0	LEISTE REGLET	7K6
K973 45 572 0	ENDPLATTE	7M5 7M8			
K973 45 573 0	BANDFUEHRUNG TAPE GUIDE	7L8			
K973 45 574 0	BANDFUEHRUNG TAPE GUIDE	7L5			
K973 45 575 0	DRUCKSTUECK PRESSURE PIECE	7L5 7L8			
K973 45 576 0	WINKEL ANGLE	7L5			
K973 45 577 0	WINKEL ANGLE	7K9			
K973 45 578 0	TRAEGERPLATTE CARRIER PLATE	7K10 7M3			
K973 45 579 0	ABDECKUNG COVER	7M5 7M11			

Teile-Nr.	Benennung	Bildtafel	Teile-Nr.	Benennung	Bildtafel
K973 45 795 3	KLAMMERPL SATZ CLAMP PLATE SET STEBBUNDKR	7.1J8	K973 47 413 3	EINSATZ INSERT HERRENKRAG	7.1D5
K973 45 795 4	KLAMMERPL SATZ CLAMP PLATE SET STEBBUNDKR	7.1H8 7.1J8	K973 47 795 3	EINSATZ INSERT STEBBUNDKR	7.1L5
K973 45 798 3	KLAMMERPL SATZ CLAMP PLATE SET KINDERKR.	7.1F8	K973 47 798 3	EINSATZ INSERT KIKRAG.MAN	7.1H5
K973 45 798 4	KLAMMERPL SATZ CLAMP PLATE SET KINDERKR.	7.1E8			
K973 45 799 9	ZWISCHENSTUECK INSERT HERRENKRAGEN	7.2E7			
K973 45 800 0	KLOBEN BLOCK	7.2E7			
K973 45 801 0	STANGE ROD	7G7			
K973 45 802 0	PLATTE PLATE	7.2E5			
K973 45 803 0	PLATTE PLATE	7.2F7			
K973 45 804 0	AUFLAGEBLECH SUPPORT PLATE	7.2F7			
K973 45 805 0	LASCHE SHACKLE	7H5			
K973 45 806 0	LASCHE SHACKLE	7G4			
K973 45 808 0	LAGERBOCK	7D3			
K973 45 813 4	BANDTRANSPORT K LINKS	7G1			
K973 45 814 4	BANDTRANSPORT K RECHTS	7F11			
K973 45 815 4	KETTF.TRENNER LINKS	7M6			
K973 45 816 4	KETTF.TRENNER RECHTS	7M8			
K973 45 817 4	KLAMMERBLOCK K RECHTS	7D6			
K973 45 818 4	KLAMMERBLOCK K LINKS	7D6			
K973 46 102 0	GEWINDEPLATTE THREADED PLATE	3M7 11E1			
K973 46 160 0	UNTERMESSE LOWER KNIFE	7M10 13E2			
K973 46 161 0	OBERMESSE UPPER KNIFE	7L9 13E2			
K973 46 162 0	DREHFEDER SPRING	7L9 13E3	K973 51 106 0	GEWINDEHUELSE THREADED BUSH	5M3 5M8
K973 46 164 0	HUELSE BUSH	7C11 9D1	K973 51 119 0	FUEHRUNGSSTANGE GUIDE ROD	5L5 5M10
K973 46 180 0	GELENKBOLZEN JOINT BOLT	11C11 11F2	K973 51 120 0	TRAEGER CARRIER	5H7
			K973 51 121 3	KLOBEN BLOCK	5J2 5J7

Teile-Nr.	Benennung	Bildtafel	Teile-Nr.	Benennung	Bildtafel
K973 51 122 0	AUFNAHME RECEPTION	5H7 5J2	K973 51 321 2	FUEHRGS STUECK GUIDE SECTION	7.4D3 7.4D8
K973 51 123 0	DRUCKSTIFT PRESSURE PIN	5H3 5H7	K973 51 322 0	ANSCHLAG GUIDE	7.4C5 7.4C7
K973 51 127 0	SCHARNIERSTUECK HINGE SECTION	6H2 6J8 7.3D2 7.3D11	K973 51 326 0	ANSCHLAG GUIDE	7.3B9
K973 51 128 0	BOLZEN BOLT	5J3 5J8 7.3D1 7.3E11	K973 51 332 0	ANSCHLAGBLECH STOP PLATE	6J11 7.2D3
K973 51 130 0	LEISTE REGLET	6H1	K973 51 332 9	ANSCHLAG GUIDE	7.2B3
K973 51 149 0	BLATTFEDER LEAF SPRING	5J4 5J7	K973 51 335 0	EINSATZ INSERT	6G5
K973 51 156 0	ROLLE ROLLER	6C12	K973 51 336 0	LEISTE REGLET	6F9
K973 51 162 3	STUETZE SUPPORT	5L6 5L11	K973 51 337 0	LEISTE REGLET	6G9
K973 51 163 0	BOLZEN BOLT	5F3	K973 51 338 0	STELLSTANGE ADJUSTING BAR	6E8
K973 51 164 0	TRAEGER CARRIER	5H3	K973 51 339 0	LAGERBOCK PILLOW BLOCK	6D1
K973 51 194 0	DRUCKFEDER PRESSURE SPRING	5H3 5H7	K973 51 340 0	LAGERBOCK PILLOW BLOCK	6C9
K973 51 195 0	BUCHSE BUSHING	5J3 5J8 7.3E11	K973 51 341 0	FUEHRUNG GUIDE	6D9
K973 51 204 3	TRAEGER CARRIER	3D5 3D8	K973 51 342 0	STANGE ROD	6D9
K973 51 206 0	ANSCHLAG GUIDE	5H2 5J8	K973 51 343 0	STUETZE SUPPORT	6D8
K973 51 244 0	WINKEL ANGLE	5G2 5H8	K973 51 344 3	AUFNAHME RECEPTION	6C5
K973 51 245 0	BUCHSE BUSHING	5G2 5H8	K973 51 345 3	AUFNAHME RECEPTION	6B8
K973 51 247 0	HEBEL LEVER	5H2 5H8	K973 51 347 0	BLECH PLATE	6F7
K973 51 267 0	PLATTE PLATE	7.3C9	K973 51 348 0	BLECH PLATE	6F7
K973 51 272 0	KLOBEN BLOCK	7.2C9	K973 51 349 0	ABDECKBLECH COVER PLATE	6F4
K973 51 273 0	BUEGEL BOW	7.2D11	K973 51 352 0	KLOBEN	6J2
K973 51 291 0	STANGE ROD	7.3C8	K973 51 353 0	LAGERBOCK PILLOW BLOCK	6J4
K973 51 292 0	FUEHRUNG GUIDE	7.3E4	K973 51 355 3	KURBEL CRANK	6D1
K973 51 293 0	STUETZE SUPPORT	7.3D6	K973 51 356 0	GELENK JOINT	6J4
K973 51 301 0	LAGERBOCK PILLOW BLOCK	7.3C8	K973 51 357 0	BOLZEN BOLT	6C4
K973 51 303 0	BUEGEL BOW	7.3C6	K973 51 363 0	ANSCHLAGPLATTE STOP PLATE	6L7 7.2D10 7.2K4
K973 51 304 0	BUEGEL BOW	7.3C7	K973 51 363 9	ANSCHLAG GUIDE	6K8
K973 51 310 0	STANGE ROD	7.3G8		HERRENKR.	
K973 51 317 0	BUCHSE BUSHING	7.3E6 9K12	K973 51 364 0	ANSCHLAG GUIDE	6L7 6L10 7.2D8 7.2G2 7.2G4 7.2J2 7.2J4
K973 51 318 0	DISTANZBUCHSE DISTANCE BUSH	7.3E4	K973 51 365 0	ANSCHLAGPLATTE STOP PLATE	6L10

Teile-Nr.	Benennung	Bildtafel	Teile-Nr.	Benennung	Bildtafel
K973 51 365 4	ANSCHLAG GUIDE KINDERKR.	6K12 7.2J4	K973 51 393 0	DISTANZSTUECK DISTANCE PIECE 18.00Z	7.4J7
K973 51 366 3	FUEHRUNG GUIDE	6D12	K973 51 394 0	DISTANZSTUECK DISTANCE PIECE 18.50Z	7.4J7
K973 51 367 0	SPANNSTUECK TENSION PIECE	7.2C11	K973 51 395 0	DISTANZSTUECK DISTANCE PIECE 19.00Z	7.4J7
K973 51 368 0	PLATTE PLATE	7.2D11	K973 51 397 0	DISTANZSTUECK DISTANCE PIECE 10	7.4K7
K973 51 369 0	LEISTE REGLET	7.2C6	K973 51 398 0	DISTANZSTUECK DISTANCE PIECE 20	7.4K7
K973 51 370 0	ANSCHLAG GUIDE	7.2D5	K973 51 399 0	DISTANZSTUECK DISTANCE PIECE 30	7.4K7
K973 51 371 0	ANSCHLAGPLATTE STOP PLATE	7.2D5	K973 51 400 0	DISTANZSTUECK DISTANCE PIECE 40	7.4L7
K973 51 371 9	FORMANSCHLAGKPL SHAPE GUIDE CPL	7.2B7	K973 51 401 0	DISTANZSTUECK DISTANCE PIECE 50	7.4L7
K973 51 372 0	HALTEBLECH HOLDING PLATE	7.2C5	K973 51 402 0	DISTANZSTUECK DISTANCE PIECE 60	7.4L7
K973 51 373 0	KLOBEN BLOCK	7.2C9	K973 51 403 0	DISTANZSTUECK DISTANCE PIECE 70	7.4L7
K973 51 374 0	HALTEBLECH HOLDING PLATE	7.2C8	K973 51 404 0	DISTANZSTUECK DISTANCE PIECE 80	7.4L7
K973 51 375 0	HALTEBLECH HOLDING PLATE	7.2B8	K973 51 405 0	DISTANZSTUECK DISTANCE PIECE 90	7.4L7
K973 51 378 0	HEBEL LEVER	7.3D4	K973 51 406 0	DISTANZSTUECK DISTANCE PIECE 100	7.4L7
K973 51 379 0	WINKEL ANGLE	7.3E11	K973 51 407 0	DISTANZSTUECK DISTANCE PIECE 110	7.4M7
K973 51 380 2	PLATTE PLATE	7.4E3 7.4E8	K973 51 408 0	DISTANZSTUECK DISTANCE PIECE 120	7.4M7
K973 51 381 0	STANGE ROD	7.3H8	K973 51 409 0	DISTANZSTUECK DISTANCE PIECE 130	7.4M7
K973 51 382 0	WINKEL ANGLE	7.3E8	K973 51 410 0	GELENK JOINT	7.3F4
K973 51 386 0	DISTANZSTUECK DISTANCE PIECE 14.50Z	7.4H7	K973 51 412 0	DISTANZHUELSE DISTANCE SLEEVE	7.3H8 7.3J9
K973 51 387 0	DISTANZSTUECK DISTANCE PIECE 15.00Z	7.4H7	K973 51 417 0	FUEHRUNG GUIDE	7.3D5
K973 51 388 0	DISTANZSTUECK DISTANCE PIECE 15.50Z	7.4H7	K973 51 418 0	KLOTZ LOG	7.3C4
K973 51 389 0	DISTANZSTUECK DISTANCE PIECE 16.00Z	7.4H7	K973 51 419 0	KLEMMFEDER CLAMPING SPRING	7.3C4
K973 51 390 0	DISTANZSTUECK DISTANCE PIECE 16.50Z	7.4H7			
K973 51 391 0	DISTANZSTUECK DISTANCE PIECE 17.00Z	7.4H7			
K973 51 392 0	DISTANZSTUECK DISTANCE PIECE 17.50Z	7.4J7			

Teile-Nr.	Benennung	Bildtafel	Teile-Nr.	Benennung	Bildtafel
K973 51 420 0	DISTANZSTUECK DISTANCE PIECE 14.75Z	7.4H10	K973 51 463 0	PLATTE PLATE	6D1
K973 51 421 0	DISTANZSTUECK DISTANCE PIECE 15.25Z	7.4H10	K973 51 464 0	ABDECKUNG COVER	3A6
K973 51 422 0	DISTANZSTUECK DISTANCE PIECE 15.75Z	7.4H10	K973 51 465 0	LEISTE REGLET	385 389
K973 51 423 0	DISTANZSTUECK DISTANCE PIECE 16.25Z	7.4H10	K973 51 466 0	KLEMMKLOBEN BLOCK	389
K973 51 424 0	DISTANZSTUECK DISTANCE PIECE 16.75Z	7.4H10	K973 51 467 0	BLATTFEDER LEAF SPRING	389
K973 51 425 0	DISTANZSTUECK DISTANCE PIECE 17.25Z	7.4H10	K973 51 468 0	LEISTE REGLET	3C6
K973 51 426 0	DISTANZSTUECK DISTANCE PIECE 17.75Z	7.4H10	K973 51 469 0	DISTANZBUCHSE	7.3E8
K973 51 427 0	DISTANZSTUECK DISTANCE PIECE 18.25Z	7.4J7	K973 51 470 0	PLATTE RE.	7.3D9
K973 51 428 0	DISTANZSTUECK DISTANCE PIECE 18.25Z	7.4J7	K973 51 471 0	PLATTE LI.	7.3C2
K973 51 433 0	BLATTFEDER LEAF SPRING	7.3D9 7.3E3	K973 51 472 0	ANSCHLAG GUIDE	7.4L3
K973 51 434 0	ANSCHLAG GUIDE	7.3A5 7.3A7	K973 51 473 0	SPANNSTUECK TENSION PIECE	7.4L3
K973 51 435 0	LEISTE REGLET	7.3D9	K973 51 474 0	PLATTE PLATE	7.4K3
K973 51 436 0	TRAEGER RE. CARRIER	7.3E11	K973 51 475 0	LEISTE	7.3F8
K973 51 437 0	TRAEGER LI. CARRIER	7.3D1	K973 51 476 0	BLECH PLATE	7.4D3 7.4D8
K973 51 438 0	KLOBEN BLOCK	7.3B5 7.3B7	K973 51 477 0	LEISTE	7.3E6
K973 51 439 0	HEBEL LEVER	7.4A3 7.4A5	K973 51 498 0	PLATTE	7.3G8
K973 51 440 0	PLATTE PLATE	7.3D11	K973 51 499 0	WINKEL	7.3F4
K973 51 441 0	BOCK SUPPORT	7.3D2 7.3D11	K973 51 500 4	EINSCHUBPLATTE PLATE CPL 973-S304	7.3A9
K973 51 442 0	FEDER SPRING	7.3B4 7.3B7	K973 51 752 9	ANSCHLAG GUIDE	7.2B11
K973 51 444 0	ANSCHLAG GUIDE	7.3C7	K974 45 041 0	ZUGFEDER SPRING	6E5
K973 51 445 0	LEISTE REGLET	6H8	K975 41 052 0	KLEMMRING CLAMPING RING	3E8
K973 51 446 0	PLATTE PLATE	6L7 6M10	K975 41 459 3	KLEMMSTUECK CLAMP PIECE	4F2 4F8
K973 51 461 0	WINKEL ANGLE	5G1	K977 40 091 0	GEHAEUSE HOUSING	4G11
K973 51 462 0	KLEMMKLOBEN BLOCK	6C1	K977 40 096 0	EXZENTERBUCHSE ECCENTR BUSH	4F11
			K980 40 054 0	FUSS FOOT	3L5 3L11 13D1
			K980 40 138 3	STELLRING ADJ RING	1M7 1M9 1M10
			K980 40 167 0	SCHEIBE DISC	1H4 2D3

Teile-Nr.	Benennung	Bildtafel	Teile-Nr.	Benennung	Bildtafel
K980 40 192 0	SCHEIBE DISC VULCOLLAN	5L6 5L11	K992 00 032 7	SENKSCHRAUBE SCREW NR.40X10	1F6
K981 15 000 2	EINSTELLKLOBEN GAUGE BLOCK	13D6	K992 00 104 0	ZYL STIFT CYLIND PIN 2,70X10,7	1C5
K981 15 000 3	LEHRE GAUGE SCHLEIFENH.EINST.	13D6	K992 00 216 0	GEWINDESTIFT THREADED PIN NR.28X 9,5	1B4
			K992 00 244 0	GEWINDESTIFT THREADED PIN NR.28X4	1L7 1M9 1M10 1M11
			K992 00 281 7	SCHRAUBE SCREW NR.88X6,	1E3
			K992 00 373 0	ZYL STIFT CYLIND PIN 5X27	7G10 7H2
			K992 00 433 7	SCHRAUBE SCREW NR.40X5	1L6
K990 49 012 8	PINZETTE TWEEZERS GEBOGEN 3884-M/150	13F1	K992 00 665 0	GEWINDESTIFT THREADED PIN NR.40X 5,	1L1
			K992 00 674 6	SENKSCHRAUBE SCREW NR.54X5	1G6
K990 81 005 4	STECKSCHLUESSEL KEY	13F1	K992 00 801 0	ZYL STIFT CYLIND PIN 6X16	7E6
			K992 00 992 0	SCHRAUBE SCREW NR.13	1K3
K990 81 007 8	KASTEN BOX 6172	13G5	K992 00 993 0	SENKSCHRAUBE SCREW NR.47X2	1L3
K990 81 008 3	BEHAELTER CONTAINER 744-0601	13M3	K992 01 243 0	GEWINDESTIFT THREADED PIN NR.18X 7,5	1C7 1D5 1J10 1M8
K990 81 008 4	MAULSCHLUESSEL WRENCH SATZ 895 3110	13E5	K992 01 341 7	RAENDELSCHRAUBE KNURLED SCREW NR.86X11	13D6
K990 81 008 5	INBUSSCHLUESSEL KEY SATZ	13B3	K992 01 353 0	SCHRAUBE SCREW NR.89X4,3	1K4
K990 81 010 1	NAEHM OEL 250GR OIL 250 GRAMS 250GR.E.SP-NK10	13M3			

Teile-Nr.	Benennung	Bildtafel	Teile-Nr.	Benennung	Bildtafel
K992 01 506 0	SENKSCHRAUBE SCREW NR.82X 2,5	3L4	K993 03 133 7	SENKSCHRAUBE SCREW M4X5	7.3D6
K992 01 510 0	SENKSCHRAUBE SCREW NR.13	1K4	K993 03 134 7	SENKSCHRAUBE SCREW M4X6	6H2 6J8 7J5 7J9
K992 01 538 0	SPEZIALMUTTER NUT NR104	7E6	K993 03 135 7	SENKSCHRAUBE SCREW M4X8	7.4B5
K992 01 727 7	MUTTER NUT NR.40	1E6	K993 03 136 7	SENKSCHRAUBE SCREW M4X10	1B8 6G8
K992 01 758 0	SCHRAUBE SCREW NR.99X10,0	1D5	K993 03 138 7	SENKSCHRAUBE SCREW M4X16	1F7 1F8
K992 01 944 0	SCHRAUBE SCREW NR.23X9,3	1C10 1M11	K993 03 722 7	SENKSCHRAUBE SCREW M3X4	7.2E5
K992 01 998 0	SCHRAUBE SCREW	3L4	K993 03 765 7	SENKSCHRAUBE SCREW M4X8	5E8
K992 02 359 0	ANSATZSCHRAUBE SHOULDER SCREW M3,5X8	1H4 9A5			
K992 02 389 0	SENKSCHRAUBE SCREW M4X9	1G6			
K992 02 464 8	GEWINDESTIFT THREADED PIN M6X30	2F1			
K992 12 310 0	SCHRAUBE SCREW M3X4,5X2,	7K9 7L2			
K993 02 016 0	ZYL STIFT CYLIND PIN 1,2M6X12	1J6	K993 06 093 7	SCHRAUBE SCREW M3X5	7M5 7M11
K993 02 083 0	ZYL STIFT CYLIND PIN 3 M6X32	1D2	K993 06 094 7	SCHRAUBE SCREW M3X6	6K10 6L7
K993 02 093 0	ZYL STIFT 4 M6X6	6E5 6E8 7J2 7J10	K993 06 095 0	SCHRAUBE M3X8	7.3B7
K993 02 123 0	STIFT PIN 5 M 6X32	2L2			9E2
K993 03 092 7	SENKSCHRAUBE SCREW M3X4 4.8 VZI	7.4C5			
K993 03 094 7	SENKSCHRAUBE SCREW M3X6	1A3 10G6	K993 06 097 7	SCHRAUBE SCREW M3X12	7J7 11E3

Teile-Nr.	Benennung	Bildtafel	Teile-Nr.	Benennung	Bildtafel
K993 06 098 7	SCHRAUBE SCREW M3X16	7D9 7F2 7F4 7J7 11E7	K993 06 737 7	SCHRAUBE SCREW M5X12	6A7 6B5 6D5 6D8 6K7 6K10 7.2C5 7.2D10 7.2G4 7.2K4 13H2 13J9 13L9
K993 06 100 7	SCHRAUBE SCREW M3X20	7M9			
K993 06 134 7	SCHRAUBE SCREW M4X6	7G4 13F7	K993 07 375 7	SCHRAUBE SCREW M5X8	1E7
K993 06 135 7	SCHRAUBE SCREW M4X8	8J2 8J10	K993 07 377 7	SCHRAUBE SCREW M5X12	3A5 3A8 3B5
			K993 08 700 8	SCHRAUBE SCREW M4X6 MLS	6A8 6B5 6E1 6E5 6G1 6G9 6H4
K993 06 139 7	SCHRAUBE SCREW M4X18	7.3L9			
K993 06 140 7	SCHRAUBE SCREW M4X20	8A3 8C9 9M1	K993 19 034 7	SCHEIBE DISC 3,2	1C1 6L7 6L10 7M5 7M11 7.4B1 7.4B6 7.4K3 11E6
K993 06 146 7	SCHRAUBE SCREW M4X40	8A9 8B1	K993 19 036 7	SCHEIBE DISC 4,3	1J5 1J6 4J7 5H2 5M8 6B8 6C5 6E9 6G1 6G9 6H4 6J4 6J5 6J7 6J8 7G4 7H6 7K10 7L2 7L5 7L8 7.3H5 7.3H7 8A9 8A11 8B1 8D9 13J3 13J12 13K10
K993 06 155 7	SCHRAUBE SCREW M5X8 VZI	7.3J7 7.3K7 7.3L9			

Teile-Nr.	Benennung	Bildtafel	Teile-Nr.	Benennung	Bildtafel
			K993 52 115 0	GEWINDESTIFT THREADED PIN M6X6	5J2 5J8
K993 19 038 7	SCHEIBE DISC B6,4	1G4 3B9 3E6 3G8 3G10 3H8 3H9 4B2 4B7 4C3 4C7 4J10 4K4 5B8 5C5 5L6 5L11 7J11 7K5 7.3E7 7.3L3 7.3L7 8D4 8D10 8F1 8G3 8G11 8H9 8.1E6 8.1E9 11C5 11K6 11K10 13B7 13C7	K993 71 065 7	NIET RIVET 3X10	8.1D5 8.1D7
			K993 83 313 6	SCHLUESSEL KEY SW 8 / 10	13G3
			K993 83 410 6	SCHLUESSEL KEY 6X7	13E1
K993 19 046 7	SCHEIBE B19	13D10			
K993 26 096 8	FLUEGELSCHRAUBE FLY SCREW M4X15	1A1			
K993 27 129 7	GEWINDESTIFT THREADED PIN M6X16	5D6			
K993 30 036 7	SCHEIBE DISC 4,3	7H8 7K7	K993 90 400 8	SCHRAUBENDREHER SCREWDRIVER F.I.6KT.SW 1,5 X40	13H1
K993 34 056 7	MUTTER NUT M4	7J4 7.3M11 11F7			
K993 34 057 7	MUTTER NUT M5	4F5 11J2	K993 91 064 8	SCHRAUBE SCREW M3X12	5C3
			K993 91 070 8	SCHRAUBE SCREW M3X6	1M9
K993 41 120 8	RAENDELMUTTER KNURLED NUT POLY M5	6A6 6B5 6D5 6D8 6L7 6L10 7.2C5 7.2D10 7.2H4 7.2K4			
K993 52 094 0	GEWINDESTIFT THREADED PIN M4X5	13H11			
K993 52 105 0	GEWINDESTIFT THREADED PIN M5X6	1C2	K993 91 081 7	SCHRAUBE SCREW M4X8	4D3 5G1 5H4 5J7 6C4 7G6 7K5 7L2 7L8 7L10 7.3B9

Teile-Nr.	Benennung	Bildtafel	Teile-Nr.	Benennung	Bildtafel
		7.3C9 7.3D9 7.3E3 7.3E11	K993 91 106 8	ZYL.SCHR. M5X20	1B2
K993 91 082 7	SCHRAUBE SCREW M4X10	6C1 6J2 7F8 7J4 7J8 7.3C3 7.3C7	K993 91 108 7	SCHRAUBE SCREW M5X25	4C3 4C5 4C7 4D5 4D7 4E10 4G3 9K12 11E3
K993 91 082 8	SCHRAUBE SCREW M4X10	8E9 8F3 7.3L12	K993 91 109 7	SCHRAUBE SCREW M5X30	7.3D8
K993 91 083 7	SCHRAUBE SCREW M4X12	2K2 5H2 5H8 7C9 7H1 7,1F11 7.1K10 7.3D2 7.3D11 11F7	K993 91 109 8	SCHRAUBE M5X30	7.3D3
K993 91 083 8	SCHRAUBE SCREW M4X12	1H5	K993 91 110 7	SCHRAUBE SCREW M5X35	4D4
K993 91 084 7	SCHRAUBE SCREW M4X16	6C9 6E9 7F10 7G3 7.3B5 7.3E7 8C2	K993 91 122 7	SCHRAUBE SCREW M6X10	7K5 7K8 8D3 8D9
			K993 91 122 8	ZYL.SCHR. M6X10	5C3
			K993 91 123 8	SCHRAUBE SCREW M6X12	7.3H7 7.3K9
K993 91 086 7	SCHRAUBE SCREW M4X20	1J5 4D3 5K5 5K10	K993 91 124 7	SCHRAUBE SCREW M6X16	3H7 3H9 3J8 5B8 5C5 7C6 7J7 8B11 8C3 8.1F6
K993 91 088 7	SCHRAUBE SCREW M4X25	6C1	K993 91 125 7	SCHRAUBE SCREW M6X18	8F1
K993 91 093 7	SCHRAUBE SCREW M4X50	8A5 8B9			8G9
K993 91 102 7	SCHRAUBE SCREW M5X10	1G3 2D6 3M7 7C7 7.3G8	K993 91 126 7	SCHRAUBE SCREW M6X20	1C4 3H10 4F10 5J2 5J3 5J7 5J8 7.3E9
K993 91 103 7	SCHRAUBE SCREW M5X12	11C1 1H5 2D1 2K3 4C4 4D3 4D4 4D7 7.3F8 7.3L6 8J2 11B4 11B8 11C11 11L6 11L10 11L11 13E9	K993 91 127 7	SCHRAUBE SCREW M6X22	4J6 4K10 7.3E9
K993 91 103 8	ZYL.SCHR. M5X12	1B2	K993 91 128 7	SCHRAUBE SCREW M6X25	3C8 3E6 3J8 4B2 4B7 4C3 4C7 4J10 4K4 5D6 5D7 8C10 8F2 8F11 8.1D10
K993 91 104 7	SCHRAUBE SCREW M5X16	2K3 2K6 4E4 4E6 4E7 4F8 8E2 8F9 11E10 11F2 11H1 13B7	K993 91 129 7	SCHRAUBE SCREW M6X30	4F2 4F8 5C5 5D8
K993 91 106 7	SCHRAUBE SCREW M5X20	3C8 3D5 4B5 4G9 5M6 5M11 7.3A2 7.3C9 7.3H10 11C7 11F4 11G11	K993 91 130 7	SCHRAUBE SCREW M6X35	4H6 4H7 5D6 5D7 5D5 5D8 7.3F8

Teile-Nr.	Benennung	Bildtafel	Teile-Nr.	Benennung	Bildtafel
			K993 92 100 8	GEWINDESTIFT THREADED PIN M5X8	1B3
K993 91 148 7	SCHRAUBE SCREW M8X25	2D3 3E8 3K10 3L7	K993 92 111 8	GEW.STIFT M6X10	1L10
K993 91 149 7	ZYL.SCHR. M8X30	5A4 5A9	K993 92 183 7	GEWINDESTIFT THREADED PIN M16X70	3K11 13C1
K993 91 150 7	SCHRAUBE SCREW M8X35	3E6 4J6 5A6 7.3K12			
K993 91 152 7	SCHRAUBE SCREW M8X45	7H3	K993 95 080 8	GEWINDESTIFT THREADED PIN M4X4	1L9
K993 91 153 7	SCHRAUBE SCREW M8X50	5A5			
			K993 96 160 7	SCHRAUBE SCREW M5X10	1E2 1E4
			K993 97 098 7	SCHRAUBE SCREW M4X8	3G9 4A1 4A8 5A3 7.2D7 13K12
			K993 99 191 0	SCHRAUBE SCREW M6X8	1A3
			K993 99 193 7	SCHRAUBE SCREW M6X12	3C6
K993 92 074 8	GEWINDESTIFT THREADED PIN M3X10	7.3A5	K994 04 148 8	6KT.SCHR. M4X10	1E1
K993 92 076 8	GEWINDESTIFT THREADED PIN M4X4	4E3	K994 04 157 7	SCHRAUBE SCREW M4X35	7H6 7J9 7L2
K993 92 098 8	GEWINDESTIFT THREADED PIN M5X5	1A2	K994 04 178 7	SCHRAUBE SCREW M5X10	8K1 8K12
			K994 04 180 7	SCHRAUBE SCREW M5X16	1H6

Teile-Nr.	Benennung	Bildtafel	Teile-Nr.	Benennung	Bildtafel
K994 04 188 7	SCHRAUBE SCREW M5X40	7.3E6	K994 25 201 7	SCHEIBE DISC 4,3	1J4 7.3B9
K994 04 192 7	SCHRAUBE SCREW M5X60	11L3	K994 29 072 0	PASSKERBSTIFT GROOVED PIN 3X10	1G6
K994 04 210 7	SCHRAUBE SCREW M6X16	7.3L4	K994 30 104 0	ZYL.KERBSTIFT 4X18	1M9
K994 04 216 7	SCHRAUBE SCREW M6X30	7J11 7.3K4 7.3L7	K994 33 075 0	KERBNAGEL SLOT NAIL 3X8	7M1 7H10 7.3A4 7.3A7 8.1D5 8.1D8
K994 04 294 7	SCHRAUBE SCREW M8X70	4F11	K994 33 088 0	KERBNAGEL SLOT NAIL 4X15	5F9
K994 04 329 7	SCHRAUBE SCREW M10X45	4K7	K994 38 022 8	SPANNHUELSE CLAMPING SLEEVE 1,5X6	1C4
K994 05 034 7	MUTTER NUT M3	1C2 5B3 6J4 7L2 7C3 7L11 7M9 11F7	K994 38 042 8	SPANNHUELSE CLAMPING SLEEVE 2,5X6	7.4A3
K994 05 037 7	MUTTER NUT M5	2K6 4C3 4C4	K994 38 047 8	SPANNHUELSE CLAMPING SLEEVE 2,5X16	2E1
K994 05 044 7	MUTTER NUT M16	3K6 3K11	K994 38 062 8	SPANNHUELSE CLAMPING SLEEVE 3X6	11F7
			K994 38 064 8	SPANNHUELSE CLAMPING SLEEVE 3X10	6J4
			K994 38 065 8	SPANNHUELSE CLAMPING SLEEVE 3X12	7G6
			K994 38 071 8	SPANNHUELSE CLAMPING SLEEVE 3X24	3C8 7H2 7H10
			K994 38 434 0	SPANNSTIFT TENSION PIN SG4X10	7M5 7M8
			K994 40 134 0	MUTTER NUT M60X1,5	2B6
			K994 46 101 7	SCHRAUBE SCREW	1D11

Teile-Nr.	Benennung	Bildtafel	Teile-Nr.	Benennung	Bildtafel
	M5X12			47X1,75	
K994 80 144 7	SCHEIBE DISC B4,3	1B8 7.2D7	K996 02 136 8	SICHERGS RING CIRCLIP 62X2	2H2 2H2
K994 80 145 7	SCHEIBE DISC B5,3	1G3 3A5 3A8 3B5 3C7	K996 06 017 0	KUGEL BALL 3,969	1D5
K994 80 146 7	SCHEIBE DISC B6,4	1G4 1J6 2M3 10E2	K996 06 025 0	KUGEL BALL 6,350	1A3
			K996 07 005 8	SICHERGSSCHEIBE SAFETY DISC 2,3	7L3 7L9 13D4
			K996 07 006 8	SICHERGSSCHEIBE SAFETY DISC 3,2	1B8 1C3 1D1 6C4 6D1 7D7 7H8 8E3 8E9 13H10
			K996 07 007 8	SICHERGSSCHEIBE SAFETY DISC 4	6C12
			K996 07 008 8	SICHERGSSCHEIBE SAFETY DISC 5	6C9 7D3 7E5 7E7 7G6 7.3C8
K995 14 021 7	RAENDELMUTTER KNURLED NUT M6	7B2 7B11	K996 07 009 8	SICHERGSSCHEIBE SAFETY DISC 6	5J9 5L4 5L8 6H2 6J4
K995 14 035 0	MUTTER NUT M5 /PA	13K9			
			K996 07 011 8	SICHERGSSCHEIBE SAFETY DISC 8	3H8 3J6 7H11 7H12 7J2 7J3
K995 34 061 7	MUTTER NUT PG11X9	13C10 13C12	K996 07 013 8	SICHERGSSCHEIBE SAFETY DISC 10	7.3H9 7.3J9
K995 43 835 0	STIFT PIN 2 M 6X10	1K2	K996 08 070 0	RI KUGELLAGER BALL BEARING 6000	3H8
K996 01 091 8	SICHERGS RING CIRCLIP 15X1	1C6	K996 08 071 0	RI KUGELLAGER BALL BEARING 12X28X8	4F11 4J6 4J7
K996 01 093 8	SICHERGS RING CIRCLIP 17X1	2F1	K996 08 348 4	RI KUGELLAGER BALL BEARING 8X19X6	2E1 2J10
K996 01 107 8	SICHERGS RING CIRCLIP 35X1,5	2J2			
K996 02 113 8	SICHERGS RING CIRCLIP 24X1,2	1L10 1L12	K996 08 537 0	RI KUGELLAGER BALL BEARING 35X62X14	2H2
K996 02 116 8	SICHERGS RING CIRCLIP 28X1,2	4E10			
K996 02 127 8	SICHERGS RING CIRCLIP	1D7 1D10			

Teile-Nr.	Benennung	Bildtafel	Teile-Nr.	Benennung	Bildtafel
K996 08 573 0	KUGELLAGER BALLBEARING 6003.2RSR	2F1 4E3	K996 61 120 0	KUGELZAPFEN BALL PIVOT A 8	7.3E4
K996 08 576 0	RI KUGELLAGER BALL BEARING 6006 2.RSR	2E2	K996 76 050 0	LAGER BEARING 30202	2D11 2E6 2H6 2H11
K996 08 656 0	RILLENKULA 6201.2RSR	4G9 7.3A3 7.3B1 7.3H11			
K996 08 657 0	RI KUGELLAGER BALL BEARING 6202.2RSR	4E9 4F8			
K996 08 822 0	RI KUGELLAGER BALL BEARING 5X16X5	7.3K7 7.3L9			
K996 08 866 0	RI KUGELLAGER BALL BEARING 609.2RSR	1L12 1M10			
K996 12 038 7	STELLRING ADJ RING A 6	6C2			
K996 12 042 7	STELLRING ADJ RING A 10	11F2 11F10	K997 70 091 1	LEITUNG,H05V-K 1X 0,75 BR	9K1
K996 12 244 8	STELLRING ADJ RING A 12	4D6 4D8 7.3K6 7.3L5 11K6 11K8	K997 70 092 9	LEITUNG,H05V-K 1X1,0 GEGN	
K996 23 023 0	KUGELLAGER BALLBEARING 1203 TV (17X40X12)	1D10			
K996 23 068 0	KUGELLAGER BALLBEARING 15X 42X13	1D6			
K996 24 511 0	LAGER BEARING 60X 95X23	2D6	K998 68 034 8	SPANNRING CLAMPING RING 8	11D12 11F3
K996 24 513 0	LAGER BEARING 32014X	2A6	K998 85 115 0	SIMMERRING SEALING RING BA 9X18X6	1L6 1L10
K996 28 031 0	DICHTRING GASKET RING A 8X14	1F10	K998 86 007 0	RING RING OR 3 X 1	1C5
K996 29 323 0	STERNGRIFF GRIP M8	11H4 11J10	K998 86 072 0	O-RING RING 12X1,5	1K2
K996 35 025 0	DICHTRING GASKET RING C 10X14	1J6	K998 86 110 0	O-RING RING 15X2	1K6
			K998 86 159 0	O-RING RING 19X4	13G9

Teile-Nr.	Benennung	Bildtafel	Teile-Nr.	Benennung	Bildtafel
K998 86 346 0	O-RING RING 40X2	1C6			
K998 86 500 0	O-RING RING 3,3X2,4	1D5 1K8 1K10			
K998 88 152 0	PASS SCHEIBE WASHER 8X14X0,5	1A3 11E4			
K998 91 014 0	SPRENGRING SPRING RING SB11	1E10			
			K999 20 085 4	BEF SCHELLE CLAMP VERNICK. 604-7	1G8
			K999 20 085 8	BEF SCHELLE CLAMP VERNICK. 604-13	1F7 7D10 7F2
K999 20 008 3	MIKROSCHALTER MICRO SWITCH BZ-2RW855	13H8			
			K999 20 098 5	MIKROSCHALTER MICRO SWITCH	7E9 7F4 7J7

Teile-Nr.	Benennung	Bildtafel	Teile-Nr.	Benennung	Bildtafel
	MZX1021306				
K999 20 100 7	EINBAUBUCHSE BUSHING MEB 240	19K6	K999 20 131 2	GEHAEUSE HOUSING 4 POLIG	7.3F4
			K999 20 131 3	BUCHSE BUSHING 163304-2MNL MS VER	7.3F4
			K999 20 160 0	STECKHUELSE RECEPTACLE A2,8X1	7D9 7E3 9E2
K999 20 128 1	ISOLIERPLATTE INSUL PLATE 231009021	7D9 7E9 7F4			

Teile-Nr.	Benennung	Bildtafel	Teile-Nr.	Benennung	Bildtafel
			K999 21 083 5	MUTTER NUT	2D11 2E6 2H11 2J6
			K999 21 083 6	SICHERGS BLECH SAFETY PLATE 999210820	2D11 2E6 2H6 2H11
			K999 21 088 1	FLANSCHLAGER FLANGE BEARING RD20 W-ASPF 204	3K7 3K10
			K999 21 092 8	ZAHNRIEMEN BELT 25T 5/2500	4L4 4L9
			K999 21 092 9	KUGELBUECHSE BALL TYPE NIPPL 20X32X45	4G5 4G8
K999 20 239 0	SCHALTER SWITCH IND. 2-DRAHT	7.3F4	K999 21 096 2	ZAHNRIEMEN BELT 15T5/1190	7.3C3 7.3K10
K999 21 070 5	GLEITLAGER SLIDE BEAR 8X 13X 2	11E12 11G3	K999 21 097 7	STOSSDAEMPFER SHOCK ABSORBER TK 21-3M	8H1 8K12
K999 21 070 6	GLEITLAGER SLIDE BEAR 6X 11X 2	11D12 11H3	K999 21 098 0	SPANNUNG TENSION DKWN 15-28	4E9
K999 21 071 9	SICHERGS BLECH SAFETY PLATE MB12	2A6	K999 22 004 2	ZYLINDER CYLINDER D19X50	8D2 8E11
K999 21 074 1	GELENKKOPF JOINT HEAD GIS 8	2K6 2K10 2K11 3J8	K999 22 035 1	BEFESTIGUNG KPL FASTENING CPL QM/771/20	8A4 8A9
K999 21 074 5	GELENKKOPF JOINT HEAD GA 8	5L3 5L8 5M4 5M9			
K999 21 075 7	FUSS FOOT 85 SHORE	3K3 3M5 3M11 13D1			
K999 21 077 3	BUCHSE BUSHING -10 X12 X10	11F3 11F10			
K999 21 079 6	BUCHSE BUSHING SINT B 51	7.3K7			

Teile-Nr.	Benennung	Bildtafel	Teile-Nr.	Benennung	Bildtafel
K999 22 051 2	VENTIL VALVE DRUCK -3/2 G1/8"	8.1B7	K999 22 072 3	ZYLINDER CYLINDER D28X19	7E6
K999 22 051 9	VENTIL VALVE MANUELL- G1/8"	2D3 2G5 7J9 7L1 8A9 8A11 8B1 8B3 8C10 8.1D6 11E1 11G2 11K5 11M6	K999 22 072 4	ZYLINDER CYLINDER D10X25	7L11 7M3
K999 22 059 9	ZYLINDER CYLINDER D12X10	1B4 7G2 7G11	K999 22 073 1	BEFESTIGUNG KPL FASTENING CPL QM/944	7.3F5
K999 22 063 0	ZYLINDER CYLINDER D20X175	11L8	K999 22 075 2	EINSATZ INSERT	1F6
K999 22 065 4	BEFESTIGUNG KPL FASTENING CPL QM/377	3M7 8B2 8B11 11E1	K999 22 075 8	VENTIL VALVE TASTRO-3/2	8.1A9
K999 22 066 6	ZYLINDER CYLINDER D16X15	7.3F5 7.3F9	K999 22 076 4	VENTIL VALVE ODER-ELEM.STECKBAR	8C11 11L4
K999 22 067 4	ZYLINDER CYLINDER D20X50	3M9 11H1	K999 22 076 8	VENTIL VALVE TASTE -3/2	11E6
K999 22 067 5	ZYLINDER CYLINDER 28X12.5	7H6	K999 22 079 7	VENTIL VALVE DROSSEL RUECK. M 5	8A3 8C10
K999 22 067 7	BEFESTIGUNG KPL FASTENING CPL QM/375	11H1	K999 22 080 1	VENTIL VALVE LEERRU-3/2	11C7 11E3
K999 22 068 3	ZYLINDER CYLINDER D8X12.5	6J3 8.1D9 8.1E4	K999 23 020 9	HUELSE BUSH K H 1228	11E5 11F12 11K6
K999 22 071 1	ZYLINDER CYLINDER D20X100	8A3 8B9	K999 23 022 9	HUELSE BUSH K H 1630	5C6
			K999 23 024 8	DICHTRING GASKET RING G12X19X3	11E5 11F12 11J6
			K999 23 054 8	DICHTRING GASKET RING G16X24X3	5C6
			K999 23 059 3	NADELLAGER NEEDLE BEARING	7.3H9
			K999 23 205 5	NADELKLANZ AKX 1226	4E7 4E8
			K999 23 301 8	LAUFSCHLEIFE LS 1226	4D6 4E8

Teile-Nr.	Benennung	Bildtafel	Teile-Nr.	Benennung	Bildtafel
K999 24 001 8	VERSCHRAUBUNG COUPLING R 1/8"	8A2 8A11 8B4 8C10 11K4	K999 24 039 0	VERSCHRAUBUNG COUPLING M 5 D 4	8A9 8B11 8E11
			K999 24 039 1	VERSCHRAUBUNG COUPLING M 5 D 4	2D2 7L11 7M2 3H6
			K999 24 039 2	VERSCHRAUBUNG COUPLING R 1/8"D 6	
			K999 24 039 4	VERSCHRAUBUNG COUPLING D4	2D4
K999 24 030 2	DOPPELNIPPEL DOUBLENIPPLE R1/8-R1/8"	8A2 8B3 8B11 8C10 8.1D6 11G2 11K4 11L1 11M6	K999 24 041 2	STECKTEIL G1/8" INNEN	8.1B12 8.1C2
K999 24 030 5	VERTEILER DISTRIBUTOR T- R1/8"	11K4 11L1			
K999 24 035 4	KUPPLUNGSSTUECK COUPLING PIECE R 1/8"	2D4 2F10	0791 001081	GARNST.ROHR YARN SUPP TUBE LANG	13C12
K999 24 038 3	VERSCHRAUBUNG COUPLING R 1/8"D 4	7E4 8A3 8.1B12 8.1C2 10H11 11L6	0791 001085	GARNST.ROHR KURZ UNTEN	13C10
K999 24 038 4	VERSCHRAUBUNG R 1/8"D 6	8.1D6	0791 001086	GARNST.ROHR KURZ OBEN	13B10
K999 24 038 5	VERSCHRAUBUNG COUPLING R 1/8"D 4	7G11 7H1 7H6 7J6 7J9 7K1 7L2 7.3E6 8A1 8A10 8B1 8B9 8C11 8.1C7 8.1C12 8.1D6 8.1D9 8.1E4 11E1 11G1 11L1 11	0791 001088	GARNST.ROHR GETEILT	13D11
			0791 001090	GARNHALTEAM K	13C10
			0791 001091	GARNHALTER KPL YARNHOLDER CPL	13B9
			0791 001093A	SCHEIBE A5,5 DIN6902-ST	13A9 13C9
			0791 001094	LINSENSCHRAUBE M5X25 4.8H BRUE	13B9 13C9
K999 24 038 6	VERSCHRAUBUNG COUPLING R 1/8" D4	8.1C7	0791 001095	MUTTER	13A9 13B9
K999 24 038 7	VERSCHRAUBUNG COUPLING R 1/8" D4	8B3 8D2 11J2 11L4	0791 001096	FADENFUEHRG KPL THREADGUIDE CPL	13B10

Teile-Nr.	Benennung	Bildtafel	Teile-Nr.	Benennung	Bildtafel		
9203	003137	Zyl.Schraube	13H8	396	150993	Mittelt.halter	1J4
9330	000067	Scheibe	13H8	994	461018	Zyl.Schr.	1G8
9203	003647	Zyl.Schr.	13I8	9120	030110	Rillenkula	1D7
9330	000087	Scheibe	13I8	999	210936	Gleitlager	1C8
9231	110107	6 Kt. Mutter	13I9	993	031387	Senkschr.	1C8
9330	000097	Scheibe	13K9, 13L11, 13M11	993	087328	Halbrd.Schr.	1E6
9205	102168	Gew.Stift	13H9	9202	002887	Zyl.Schr.	1G4
9203	313657	Senkschr.	13I12	9330	000127	Scheibe	1G3
9203	003637	Zyl.Schr.	13L11	9231	000377	6 Kt. Mutter	1F7
9202	002517	Zyl.Schr.	13L12	396	170160	Fadenführung	1F7
9210	023377	Rändelschr.	13L11	396	110310	Buchse	1F7
9840	120229	Beg.Schelle	13M11	973	431330	Druckfeder	1G8
9825	190104	Stecker, Netz	13M8	396	110260	Fadensp.Buchse	1G8
9840	303003	Leitung	13M9	396	110470	Druckfeder	1G8
9231	110177	6 Kt. Mutter	13B1	995	140350	Rändelmutter	1G8
9081	500051	Schraubendreher	13E1	396	170154	Vorspannung K	1G8
9081	500010	Schraubendreher	13F1	396	170170	Gew.Bolzen	1G7
9201	112447	6 Kt. Schr.	13C6	9202	002927	Zyl.Schr.	1A6
9825	810411	Sicherung T1	13A2	718	015236	Nadelhülse	1B7, 1C7
9825	810413	Sicherung T1,6	13A2	396	105410	Lagerbuchse	1B7
9825	810415	Sicherung T2,5	13A2	396	105420	Antriebsrad	1C7
9825	810417	Sicherung T6,3	13B2	9202	001678	Zyl.Schr.	1B6
9825	810419	Sicherung T10	13A4	990	921371	Nadel	1G12
App	000301	Schutzhülle	13C6	9305	003290	Spannstift	11H5
0052	000369	Ölkanne	13M5	9203	313667	Senkschr.	11G9
9822	633000	Lampe	13A4	9202	002487	Zyl.Schr.	11J5, 11J4, 11K10
973	250014	Nadelst.Lehre K	13H2	9330	900127	Scheibe	11J10
781	120014	Stiftschraube	13H2	9202	002517	Zyl.Schr.	11H12
211	007178	Schaftschraube	13H2	9231	110107	6 Kt. Mutter	11K6
9231	000368	6 Kt.Mutter	13H2, 13I1	9731	005004	Schlauch	11L4
973	250020	Scheibe	13I2	9710	043020	Ventil, Pneum.	11K4
9231	000348	6 Kt. Mutter	13I2, 13K1	9800	190001	Motor, Spaltpol.	13H11
504	170270	Bolzen	13I2	996	120347	Stellring	13H11
973	250030	Stichplatte	13I1	993	523000	Gew.Stift	13J11
973	250040	Lehre	13K1	K061	000560	Spule	13K12
9330	000127	Scheibe	3C6, 4G11, 5A4, 5A9	556	013153	Senkschr.	13K12
9202	003728	Zyl.Schr.	3F6	271	000251	Schneidklemme	13J10
9330	000137	Scheibe	3F6, 3D9	9231	110057	6 Kt. Mutter	13J9
9203	003067	Zyl.Schr.	3C7	739	000402	Abdeckkappe	13H8
9330	900077	Scheibe	3C7	9870	396001	Leitungssatz K	13L8
9201	112897	6 Kt. Schr.	3C7	9205	102168	Gew.Stift	13H9
9330	900107	Scheibe	3D7	9203	003137	Zyl.Schr.	13H8
9202	003337	Zyl.Schr.	3D9	9330	000067	Scheibe	13H8
9201	112897	6 Kt. Schr.	3D8	9231	110107	6 Kt. Mutter	13I9
9330	900107	Scheibe	3D8	9330	000087	Scheibe	13I8
9231	110127	6 Kt. Mutter	3B9	9330	000097	Scheibe	13I9, 13L11, 13M11
9201	113777	6 kt. Schr.	3F9	9203	003647	Zyl.Schr.	13I8
9231	110137	6 Kt. Mutter	3F9	9203	313657	Senkschr.	13I12
9202	003387	Zyl.Schr.	3E11	9203	003637	Zyl.Schr.	13L11
9202	003767	Zyl.Schr.	3E10	9202	002517	Zyl.Schr.	13L12
9330	000137	Scheibe	3E10, 3F10	9210	023377	Rändelschr.	13L11
9202	003728	Zyl.Schr.	3E10	9840	120229	Bet.Schelle	13M11
9330	000097	Scheibe	4C3,4C5,4C7,4C4,4I 4F4,4F5,4E7,4G8,4C	9825	190104	Stecker, Netz	13M8
9205	102168	Gew.Stift	4K4,4I8	9840	303003	Leitung	13M9
9202	002987	Zyl.Schr.	4K6	973	517954	Einschubpl.K	6A11
9330	000107	Scheibe	4K6	9330	000097	Scheibe	6C12, 6G9
9231	110107	6 Kt. Mutter	4F5	9203	313637	Senkschr.	6D8, 6G9
996	086570	Rillenkula	4E1	9203	313697	Senkschr.	6E5, 6E9
9203	313677	Senkschr.	5K11, 5K6	999	240364	Steckteil	6I2
9231	110137	6 Kt. Mutter	5M8,5M4,5L8,5L3	9203	003648	Zyl.Schr.	7I1, 7G11
9202	003307	Zyl.Schraube	5M3,5M8,5H3,5H7	973	458300	Abstreiferblech	7I1, 7H11
9330	000127	Scheibe	5A4, 5A9	993	910837	Zyl.Schr.	7G10
9330	000087	Scheibe	5G1	993	911527	Zyl.Schr.	7H9
9202	002057	Zyl.Schr.	5H2, 5H8	9330	000127	Scheibe	7H9, 7H3
9332	500130	Federscheibe	5H2, 5H8	9330	000087	Scheibe	7G3, 7G10
9202	043297	Zyl.Schr.	5H3, 5H7	9203	003707	Zyl.Schr.	7H3, 7H11
9203	313657	Senkschr.	5F9	9202	002987	Zyl.Schr.	7I2
9202	002088	Zyl.Schr.	1B11	973	458124	Klammerblock K	7C6
973	404900	Gurtrad	1B11	973	458114	Klammerblock K	7D6
9205	102498	Gew.Stift	1B11	9202	002897	Zyl.Schr.	7G8, 7G6, 7D5
973	405140	Gew.Stift	1B11	9202	002377	Zyl.Schr.	7F9
9041	101052	Öldocht	1C10	9202	002067	Zyl.Schr.	7G6
9202	002518	Zyl.Schr.	1D8	9202	002087	Zyl.Schr.	7F5
9202	003297	Zyl.Schr.	1G10	9203	003777	Zyl.Schr.	7C4
9357	000090	Sich.Scheibe	1J10	973	457579	Adapter K	7B7
9790	020010	T-Verb.Stück	1K10	9203	313667	Senkschr.	7E10, 7F4
9205	102168	Gew.Stift	1K7	9203	003657	Zyl.Schr.	7D10, 7F2
				9202	002377	Zyl.Schr.	7L5, 7L8

Teile-Nr.	Benennung	Bildtafel
9202 003307	Zyl.Schr.	7K4, 7K9
9330 000127	Scheibe	7K4, 7K9, 7K3
9231 110147	6 Kt. Mutter	7M3, 7M10
9305 001680	Spannstift	7L7
9202 002987	Zyl.Schr.	7.3A4, 7.3I12
9330 000087	Scheibe	7.3B5, 7.3C7, 7.3L12
9330 000067	Scheibe	7.3C7
9203 003067	Zyl.Schr.	7.3D4
999 201314	Stift	7.3F4
9330 000097	Scheibe	7.3G7
9202 002057	Zyl.Schr.	7.3H5, 7.3H7
9330 000107	Scheibe	1B7
9330 000097	Scheibe	1B7, 2D1
895 361370	Zyl.Stift	1B2
9201 111278	6 Kt. Schr.	1B1
999 210936	Gleitlager	1C1
9201 112457	6 Kt. Schr.	1E1
9330 000087	Scheibe	1E1
396 121000	Lenkerbolzen	1B3
9205 101548	Gew.Stift	1C5
9202 004127	Zyl.Schr.	2D6
9202 002897	Zyl.Schr.	2A6
9330 000127	Scheibe	2F8, 2I11, 2K11, 2K10
9202 003307	Zyl.Schr.	2F8
9202 003737	Zyl.Schr.	2H9, 2D10
9202 003317	Zyl.Schr.	2H11, 2I10, 2I7
9231 110137	6 Kt. Mutter	2K11, 2K10
9330 000127	Scheibe	2I10, 2I7, 3K11, 3K7
9330 000137	Scheibe	3K11, 3K8
9202 003728	Zyl.Schr.	3K11, 3K7
9202 003767	Zyl.Schr.	3K8
9231 110137	6 Kt. Mutter	3L8, 3L7, 3I9
9330 000127	Scheibe	3I9, 3F1
9231 110127	6 Kt. Mutter	3G7
9357 000090	Sich.Scheibe	3E3
9706 000450	Stoßdämpfer	3E3
9201 113757	6 Kt. Schr.	3G4
9330 900127	Scheibe	3G4.3H4
9231 110137	6 Kt. Mutter	3H4
9205 103848	Gew.Stift	3K6
9202 002897	Zyl.Schr.	3E3
9330 000107	Scheibe	3E3
9706 000450	Stoßdämpfer	3F3
9231 000453	6 Kt. Mutter	3F4
9202 003387	Zyl.Schr.	3E4
9330 900137	Scheibe	3E6
993 911037	Zyl.Schr.	1F4
9203 313068	Senkschr.	1G4
9231 110038	6 Kt. Mutter	1E5
9330 000068	Scheibe	1E5
396 110700	Halteblech	1E5
9870 973008	Leitung K	1F5
9840 120203	Bet.Schelle	1E6
9305 000840	Spannstift	1G4
9205 101878	Gew.Stift	1H5
396 103734	Kopfdeckel K	1F4
396 103730	Kopfdeckel	1F5
396 111960	Bügel	1G5
396 111950	Platte	1G5
396 105444	Handrad K	1B11
558 001280	Scheibe	3B5, 3B10
9870 973007	Leitung K	1F6
9130 221020	Zahnriemen	1E12
9130 221020	Zahnriemen	2I2
9202 003328	Zyl.Schr.	2K5
973 404890	Flansch	2L5
973 404943	Gurtrad V	2I3
9202 002498	Zyl.Schr.	2H5
9353 000550	Sich.Ring	2E2
9305 002510	Spannstift	2E2
9202 003187	Zyl.Schr.	2K5
9330 000107	Scheibe	2K5
973 404880	Motorplatte	2I5
996 010938	Sich.Ring	2L4
996 085730	Rillenkula	2K4
973 405100	Hakenschraube	2B4
9231 110147	6 Kt. Mutter	2B3
9330 900137	Scheibe	2B3

Teile-Nr.	Benennung	Bildtafel
973 405100	Hakenschrauben	3B4
9231 110147	6 Kt. Mutter	3B3
9330 900137	Scheibe	3B3
9305 002440	Spannstift	3E3
973 405000	Halter	3E3
0002 0090229500	Tesamoll	3E3
973 405010	Bügel	3E3
973 405060	Winkel	3F11
9203 003677	Zyl.Schr.	3E11
9203 003697	Zyl.Schr.	3E11
9203 313677	Senkschr.	3F11
9231 110057	6 Kt. Mutter	3F11
0557 003000	Buchse	3B11
973 405050	Platte	3D12
9203 313717	Senkschr.	3D12
9202 002888	Zyl.Schr.	3I11, 3E11
973 406070	Leiste	3I11
973 405080	Leiste	3D9
798 423106	Grenztaster	3E12
9201 112897	6 Kt. Schr.	3A3
746 013020	Klemmstück	3B3
9305 002520	Spannstift	2K3
973 404980	Ritzel	4E11
9202 002568	Zyl.Schr.	4G11
973 404970	Flansch	4G11
973 405110	Abdeckung	4D11
9202 002487	Zyl.Schr.	4C11
9330 000097	Scheibe	4D11
699 989208	TF.Feilenbl. ST3	6I11
9202 002887	Zyl.Schr.	8G3, 8G9
9203 003657	Zyl.Schr.	8I2, 8I10
9357 000090	Sich.Scheibe	8K3, 8K9
9231 011147	6 Kt. Mutter	8K1, 8I11
9850 001004	Bedienfeld K	9A2
9800 580007	Motor, Schritt	9A5, 9C7, 9C8
973 404960	Buchse	9C8
999 280202	Motor, Getriebe	9C5
999 280203	Motor, Getriebe	9C5
973 404933	Zahnriemenrad	9D5
9202 003337	Zyl.Schr.	9E6
9330 000127	Scheibe	9E6
9231 110137	6 Kt. Mutter	9E6
999 280214	Motor, Getriebe	9E5
999 280215	Motor, Getriebe	9E5
9800 327003	Positionsgeber	9C10
9800 130011R	Nähantrieb	9E8
9800 331011	Steuerkasten	9F10
973 405090	Abdeckung	9H3, 9I5
9204 201677	Linsenschr.	9I3, 9I5
9870 973003	Linsenschr.	9H3
999 201608	Fußschr.Schalter	9H9
9880 973007	Fuß-Schalter K	9I9
Z100 010701	Knieschalter	9H12
9825 110301	Stecker	9I12
9204 201037	Linsenschr.	9I9, 9I11
MG50 010392	Kappe	9K9, 9K11
9830 502001	Distanzbolzen	9K7, 9L11
MG50 010391	Winkel	9K7, 9L12
9830 501003	Distanzbuchse	9K7, 9K12
9850 805006	Leiterplatte K	9K7, 9K12
9870 973009	Verteiler K	9L7, 9K12
9850 973001	Steuerung K	9M6
9830 402011	Schaltschrank	9M6
9120 030030	Rillenkula	7.3E9
9231 110127	6 Kt. Mutter	7.3L3
9202 002377	Zyl.Schr.	7.4D11
9202 002077	Zyl.Schr.	7.4D10
9203 003067	Zyl.Schr.	7.4K4
9202 002057	Zyl.Schr.	7.4C7
9330 000087	Scheibe	7.4C7
9203 003027	Zyl.Schr.	7.4A6, 7.4A1
9330 000067	Scheibe	7.4A6, 7.4B1
9231 110057	6 Kt. Mutter	7.4A3, 7.4A5
9305 001230	Spannstift	7.4B3
9203 003657	Zyl.Schr.	7.4E3
9203 313647	Senkschr.	11B2
9202 002507	Zyl.Schr.	11B1, 11B10, 11B10
9330 900107	Scheibe	11B1, 11B10

Teile-Nr.	Benennung	Bildtafel	Teile-Nr.	Benennung	Bildtafel
9330 000097	Scheibe	11B1, 11B9, 11B10 11C1,11D1,11E2,11I3 11I5,11K6,11L6,11K8 11K10,11L11,11M10,11C11			
9202 002487	Zyl.Schr.	11B9, 11C11			
9202 002987	Zyl.Schr.	11C5			
9202 002477	Zyl.Schr.	11D1			
9202 002777	Zyl.Schr.	11C2, 11C10			
9203 313977	Senkschr.	11C2, 11C10			
9202 002497	Zyl.Schr.	11F2, 11E10,11H2			
996 070088	Sich.Scheibe	11F3, 11C11			
9202 002517	Zyl.Schr.	11F11, 11F5			
9330 000087	Scheibe	11F7, 11D8			
9202 002057	Zyl.Schr.	11D8			
9710 001010	Ventil, Pneum.	11F4			
9330 900127	Scheibe	11H3			
993 151157	Halbrd.Holzschr.	3D2			
9800 327003	Positionsgeber	9C10			
9800 130011R	Nähantrieb	9E8			
9800 331011	Steuerkasten	9F10			
973 405090	Abdeckung	9H3, 9I5			
9204 201677	Linsenschr.	9I3, 9I5			
9870 973003	Schaltschrank	9H3			
Z100 010701	Knieschalter	9H12			
9330 000097	Scheibe	11B8,11L3,12M3,12M5,13H7			
9330 000127	Scheibe	3D9,3E5,7L11			
9203 314717	Senkschr.	3B4, 3B10			
9332 500130	Federscheibe	1B8			
999 260035	Bandsäge	10I3			
973 457449	Bandsäge K	10I4			
973 457349	Anschlag K	10K4			
973 457340	Anschlag	10K4			
973 403610	Spannmutter	10K4			
973 458194	Kettfadentrenner K	7M6			
973 458204	Kettfadentrenner K	7M8			
9202 002377	Zyl.Schr.	7D9,7I4,7.1F12,7.1K11			
9231 110137	6 Kt. Mutter	7K3, 3D9			
9231 110127	6 Kt. Mutter	7L10,2M3, 13B7, 7.3M7			
9237 651047	Einschlagmutter	1F7			
9202 002057	Zyl.Schr.	1I4, 1K5			
0797 002203	L-Verb.Stück	1H7			
0744 009801	Kuppl.Teil	2F10,8.1C2, 8.1C12			
9203 313697	Senkschr.	6E1			
9202 002887	Zyl.Schr.	7.1A3, 7.1E3, 13I6			
9205 102168	Gew.Stift	4D2			
973 457579	Adapter K	7.1E11			
973 457919	Einschn.Einr.K	8L2			
9203 113721	Flachkopfschr.	1D5			
9202 002897	Zyl.Schr.	8.1F6, 8.1E9			
291 000159	Fadenführung	1F3			
9203 312411	Senkschr.	1F3			
396 121360	Bolzen	1F3			
9205 101528	Gew.Stift	1F2			
396 120994	Nadelstange	1F3			
9203 111817	Flachkopfschr.	1F3			
9330 000097	Scheibe	12C5			
9202 002507	Zyl.Schr.	12C5			
9203 003047	Zyl.Schr.	7.2G2,7.2G4,7.2I4,7.2I2,7.2C8			
9330 000067	Scheibe	7.2G2,7.2G4,7.2I4,7.2I2,7.2C8			
973 513630	Anschlagplatte	7.2H4			
973 513659	Festanschlag K	7.2I4			
973 513650	Anschlagplatte	7.2K4			
9330 000087	Scheibe	7.2E6			
9203 003642	Zyl.Schr.	7.2E7			
9203 313657	Senkschr.	7.2F6			
9203 003657	Zyl.Schr.	7.2C10			
9203 003677	Zyl.Schr.	7.2D11			
9202 002887	Zyl.Schr.	7.1H3			
9203 314717	Senkschr.	3B4,3B10			
999 230229	Kugelbüchse	4H5, 4H9			
999 230548	Simmerring	4I6, 4H9			