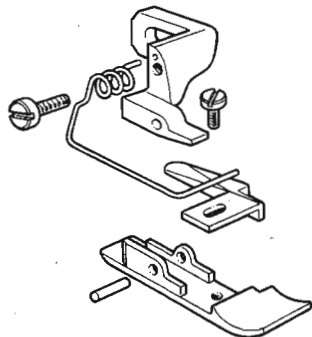

PIEDINO
PRESSER FOOT
PIED-PRESSEUR
DRUECKERFUSS

Rimoldi**PIEDINO****PRESSER FOOT****PIED PRESSEUR****DRUECKERFUSS**

Indice				TAB	R300
Data				Foglio 1	Segue F. 2

200767-3-10

Serve per
Serves for
Pour machines
Dient fuer

023-04-01
023-04-03
023-04-04

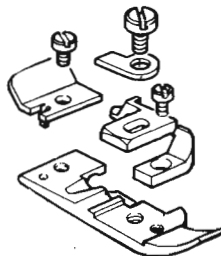
202171-3-10

Serve per
Serves for
Pour machines
Dient fuer

327-00-1CD-01
327-00-1CD-07
028-00-03
228-00-01
228-00-05

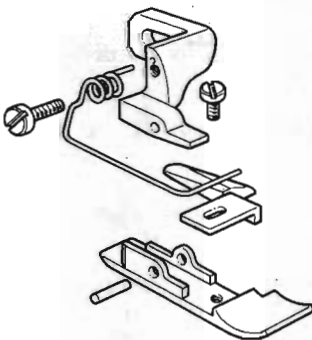
200791-3-10

Serve per
Serves for
Pour machines
Dient fuer

023-04-02
023-04-05

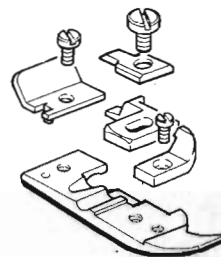
202172-3-10

Serve per
Serves for
Pour machines
Dient fuer

327-00-1CD-01
327-00-1CD-07
327-01-1CD-01

Si rende noto che il contenuto della presente tavola
non è da considerarsi un'opera di ingegneria, ma
meramente divulgativo a terzi o viziato, sia integral-
mente che parzialmente senza l'autorizzazione scritta
della stessa azienda, tutelata i suoi diritti e forma di legge.

Indice
Data
Vr.

modifiche

Si rende noto che il contenuto della presente tavola non potrà essere utilizzato o riprodotto, in tutto o in parte, senza permesso scritto dalla Rinaldo s.p.a. in viale dell'Industria, 10 - 20139 Milano. La stessa intende tutelare i suoi diritti e norme di legge.

Indice	
Data	
Vr.	



202178-3-10

Serve per
Serves for
Pour machines
Dient fuer

327-01-1CD-02
327-01-1CD-04
327-01-1CD-05
028-01-02
028-01-04
228-01-01
228-01-03
228-01-04

202509-3-10

Serve per
Serves for
Pour machines
Dient fuer

327-00-1CD-01
327-00-1CD-07
327-01-1CD-01
028-00-01
028-00-03
028-01-01
228-00-01
228-00-05

202182-3-10

Serve per
Serves for
Pour machines
Dient fuer

327-29-1CD-03
028-29-03

202641-3-10

Serve per
Serves for
Pour machines
Dient fuer

327-28-1CD-11
028-00-08
228-00-08

Rumoldi

PIEDINO

PRESSER FOOT

PIED PRESSEUR

DRUECKERFUSS

Indice				TAB	R300
Data				Foglio 5	Segue F. 6

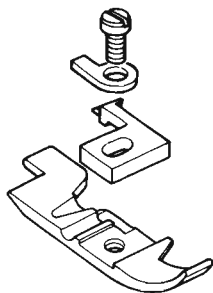
202646-3-10

Serve per
Serves for
Pour machines
Dient fuer

327-00-1CD-03
028-00-05
228-00-03

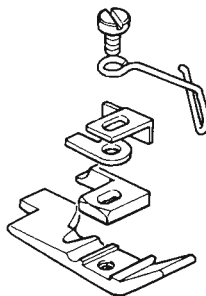
202732-3-00

Serve per
Serves for
Pour machines
Dient fuer

327-00-1CD-02
228-00-14

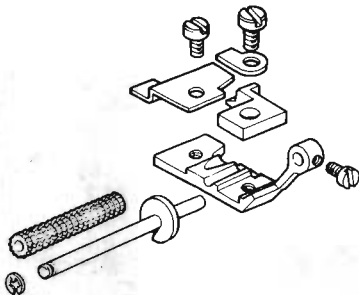
202710-3-10

Serve per
Serves for
Pour machines
Dient fuer

028-30-01

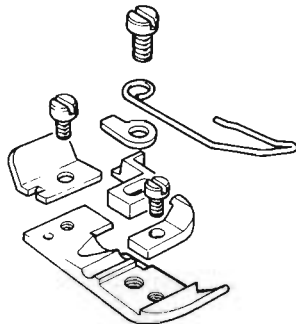
202752-3-10

Serve per
Serves for
Pour machines
Dient fuer

028-10-01

Si rende noto che il contenuto della presente tavola non deve essere utilizzato o riprodotto in tutto o in parte senza permesso scritto dalla Direzione Generale della Rumoldi S.p.A. V.le della Libertà, 10 - 37069 Verona (Italia). La Rumoldi S.p.A. non si assume alcuna responsabilità per l'uso non autorizzato della presente tavola.

Indice
Data
Vr.

modificata

Rimoldi**PIEDINO****PRESSER FOOT****PIED PRESSEUR****DRUECKERFUSS**

Indice	TAB	R300
Data	Foglio 7	Segue F. 8

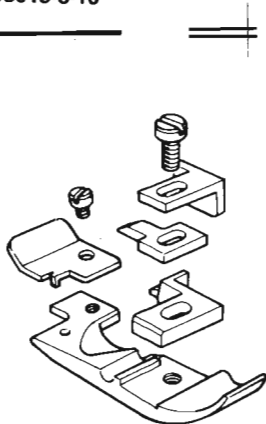
203015-3-10

Serve per
Serves for
Pour machines
Dient fuer

327-00-1CD-06
028-00-02
228-00-04

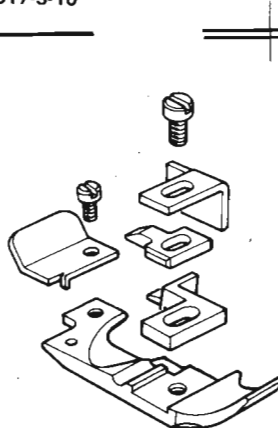
203017-3-10

Serve per
Serves for
Pour machines
Dient fuer

327-00-1MD-33

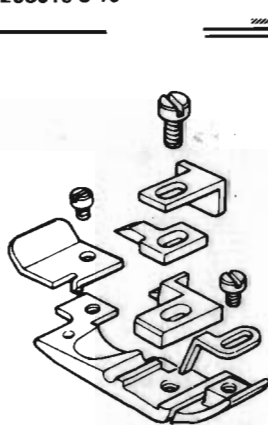
203016-3-10

Serve per
Serves for
Pour machines
Dient fuer

327-01-1CD-03
327-01-1CD-06
028-01-03
228-01-02

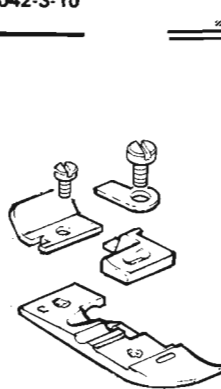
203042-3-10

Serve per
Serves for
Pour machines
Dient fuer

327-01-1CD-03
028-01-03
228-01-02

Indice
Data
V.

Modifiche

Si rende noto che il contenuto della presente tavola non potrà essere utilizzato o riprodotto, né copiato, senza permesso scritto dalla Rimoldi S.p.A. V.le della Libertà, 10 - 20139 Milano. La stessa intende tutelare i suoi diritti in forma di legge.

203050-3-10



Serve per
Serves for
Pour machines
Dient fuer

327-00-1CD-25
028-00-20
028-30-03
228-00-11

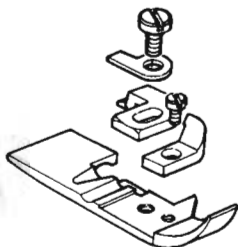

203077-3-10



Serve per
Serves for
Pour machines
Dient fuer

327-00-1CD-26
028-00-21
028-00-23
028-30-05
028-30-06
228-00-12



203053-3-10



Serve per
Serves for
Pour machines
Dient fuer

028-30-04

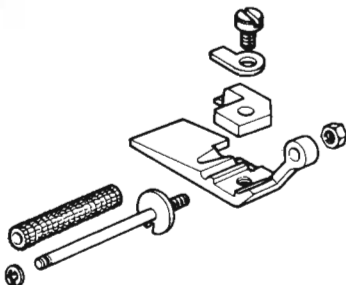

203154-3-10



Serve per
Serves for
Pour machines
Dient fuer

327-29-1CD-04
028-29-04

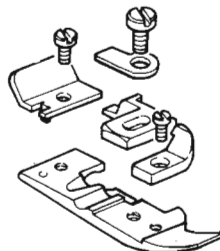

modifiche

Indice	Indice
Data	Data
V.	V.



Si rende nota che il contenuto della presente tavola non rappresenta un diritto di proprietà intellettuale, ma è un documento di lavoro che potrà essere ristampato o copiato senza permesso dalla Rumoldi s.p.a. stessa, inteso tutelare i suoi diritti.

Rumoldi

PIEDINO

PRESSER FOOT

PIED PRESSEUR

DRUECKERFUSS

Indice

TAB

R300

Data

Foglio 11 | Segue F.12

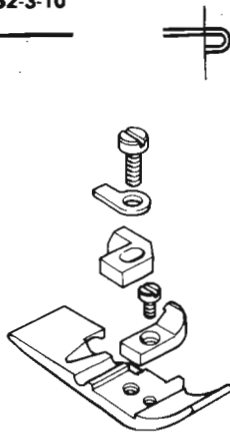
203362-3-10

Serve per
Serves for
Pour machines
Dient fuer

327-00-1CD-09
327-00-1CD-39
028-00-06
228-00-06
228-00-17
228-00-18

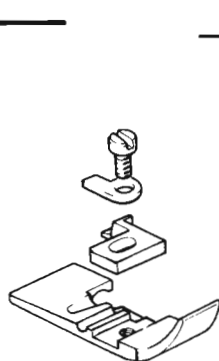
203400-3-10

Serve per
Serves for
Pour machines
Dient fuer

028-30-02

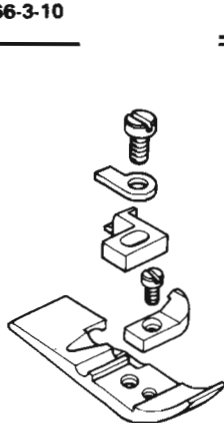
203366-3-10

Serve per
Serves for
Pour machines
Dient fuer

327-00-1CD-10
327-28-1CD-11
028-00-07
028-00-08
228-00-07
228-00-08

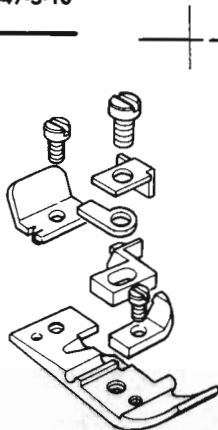
203447-3-10

Serve per
Serves for
Pour machines
Dient fuer

327-00-2CD-12
327-00-2CD-13
327-00-2CD-34
327-00-2CD-38
327-00-2CD-44
028-00-09
028-00-10
228-00-09
228-00-10

Si rende noto che il contenuto della presente tavola non potrà essere utilizzato o rappresentato né copiato, né ristampato, né riprodotto in alcun modo senza la permesso scritto dalla proprietaria S.p.A. V. I. DI & C. La stessa intende tutelare i suoi diritti in forma di legge.

Indice
Data
Vr.

modifiche

Arnold

PIEDINO

PRESSER FOOT

PIED PRESSEUR

DRUECKERFUSS

Indice	TAB	R300
Data	Foglio 13	Segue F.14

203597-3-10

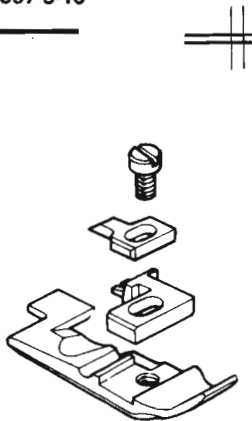

Serve per
Serves for
Pour machines
Dient fuer

327-00-2CD-16
327-00-2CD-41
028-00-13

203721-3-10

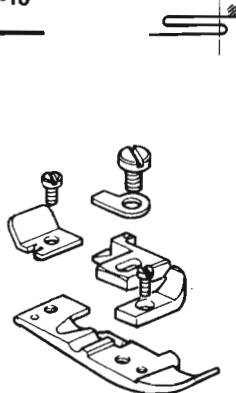

Serve per
Serves for
Pour machines
Dient fuer

327-11-1CD-01
028-11-01

203618-3-10

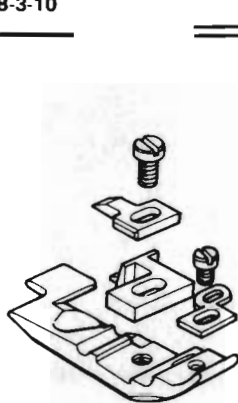

Serve per
Serves for
Pour machines
Dient fuer

327-01-2CD-05
028-01-05..

203765-3-10

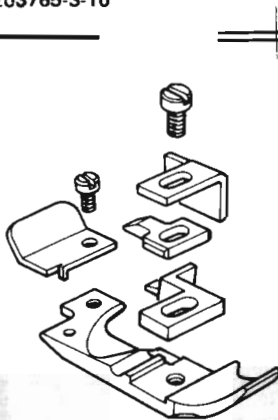

Serve per
Serves for
Pour machines
Dient fuer

327-00-1MD-23
327-00-1MD-34
028-00-18

Si rende noto che il contenuto della presente tavola non potrà essere utilizzato o ristampato senza permesso scritto dalla proprietaria S.p.A. V. Lodi & C. La stessa intende tutelare i suoi diritti in conformità di legge.

Indice
Data
Vr.
modellino

Arnoldi

PIEDINO

PRESSER FOOT

PIED PRESSEUR

DRUECKERFUSS

Indice	R300	
Data	Foglio 15	Segue F.16

203796-3-00

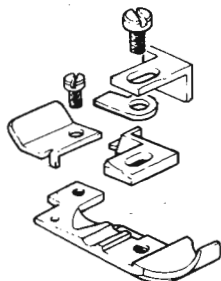

Serve per
Serves for
Pour machines
Dient fuer

327-00-1CD-06/103-90
028-00-02/103-90
228-00-04/103-90

203803-3-10

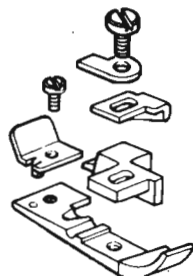

Serve per
Serves for
Pour machines
Dient fuer

327-00-1CD-27
028-00-22

203800-3-10

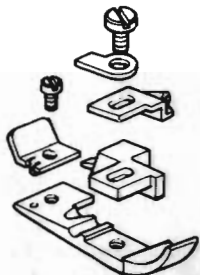

Serve per
Serves for
Pour machines
Dient fuer

327-29-1CD-08
028-29-07

203815-3-10

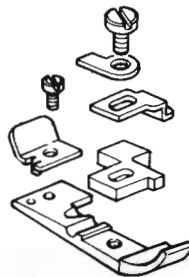

Serve per
Serves for
Pour machines
Dient fuer

327-00-1CD-29
028-00-24

Indice
Data
V.

modifiche

Si rende noto che il contenuto della presente tavola non potrà essere utilizzato o rappresentato né comunque divulgato a terzi o riprodotto sia integralmente che in parte, senza il permesso scritto della proprietaria S.p.A. Arnoldi & C. La stessa intende tutelare i suoi diritti e firma di legge.

Remoldi**PIEDINO****PRESSER FOOT****PIED PRESSEUR****DRUECKERFUSS**

Indice

TAB

R300

Data

Foglio 17

Segue 18

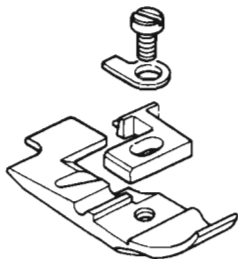
204017-3-10

Serve per
Serves for
Pour machines
Dient fuer

327-00-2CD-18
327-00-2MD-36
028-00-15
028-00-16

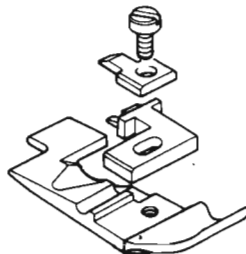
204037-3-10

Serve per
Serves for
Pour machines
Dient fuer

327-00-2CD-14
327-00-2CD-15
327-00-2CD-17
327-00-2CD-35
327-00-2CD-39
327-00-2CD-45
327-00-2MD-20
327-00-2MD-21
028-00-11
028-00-12
028-00-14
028-00-17

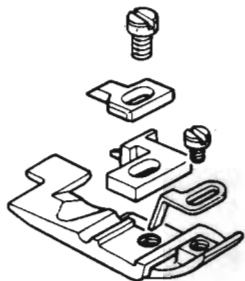
204028-3-10

Serve per
Serves for
Pour machines
Dient fuer

327-01-2CD-05
327-01-2CD-10
327-01-2CD-12
327-01-2CD-13
327-01-2MD-07
028-01-05
028-01-07

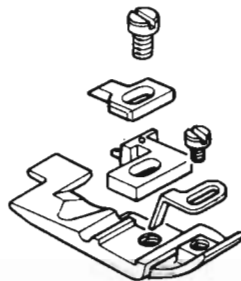
204038-3-00

Serve per
Serves for
Pour machines
Dient fuer

327-01-2MD-07
028-01-07

Indice
Data
V.

modifiche

Si rende noto che il contenuto della presente tavola è di proprietà esclusiva della Remoldi & C. La stessa intende tutelare i suoi diritti e, norma di legge, non intende consentire a terzi o ripubblicare integralmente o parzialmente senza l'autorizzazione scritta della proprietaria S.p.A. V. Remoldi & C. La stessa intende tutelare i suoi diritti e, norma di legge,

Rimoldi**PIEDINO****PRESSER FOOT****PIED PRESSEUR****DRUECKERFUSS**

Indice	TAB	R300
Date	Foglio 18	Segue F19

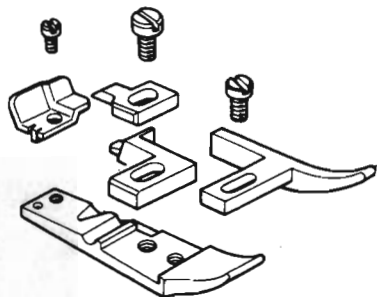
204051-3-10

Serve per
Serves for
Pour machines
Dient fuer

327-34-1MD-02
228-34-01

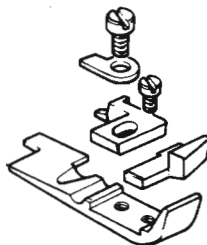
204439-3-12

Serve per
Serves for
Pour machines
Dient fuer

228-10-04

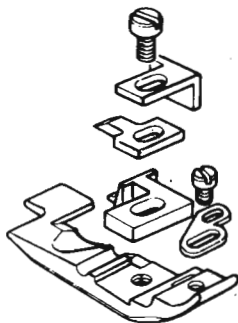
204057-3-10

Serve per
Serves for
Pour machines
Dient fuer

327-01-2MD-07
028-01-07

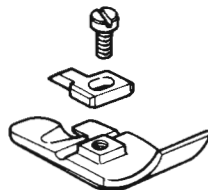
204525-3-11

Serve per
Serves for
Pour machines
Dient fuer

028-28-09
228-28-09

Si veda noto che il contenuto della presente tavola non potrà essere utilizzato o rappresentato né come intero né parzialmente senza il permesso scritto della proprietaria S.p.A. V. V. Di S. C. La stessa intende tutelare i suoi diritti e non si riserva il diritto di legge.

modifiche

V./r.	Indice	Data

Rumoldi

PIEDINO

PRESSER FOOT

PIED PRESSEUR

DRUECKERFUSS

Indice				TAB	R300
Date	Foglio 19			Segue F20	

204526-3-11

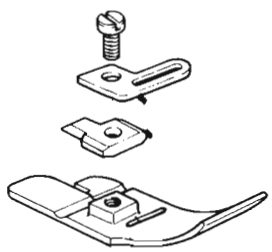

Serve per
Serves for
Pour machines
Dient fuer

028-29-08

204592-3-11

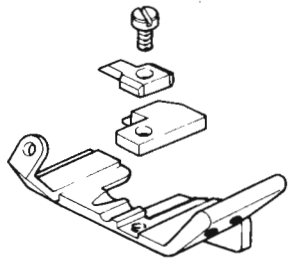

Serve per
Serves for
Pour machines
Dient fuer

028-28-10
028-28-11
228-28-08
228-28-11

204571-3-11

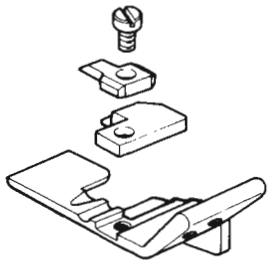

Serve per
Serves for
Pour machines
Dient fuer

028-28-10
028-28-11
228-28-08
228-28-11

204611-3-11

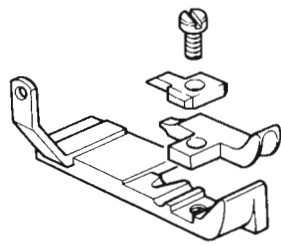

Serve per
Serves for
Pour machines
Dient fuer

028-00-19
228-00-16

Indice
Date
Vr

Si rende noto che il contenuto della presente tavola non potrà essere utilizzato o rappresentato in modo alcuno senza permesso scritto dalla proprietaria S.p.A. V. P. Rumoldi & C. La stessa intende tutelare i suoi diritti.

Renoldi

PIEDINO

PRESSER FOOT

PIED PRESSEUR

DRUECKERFUSS

Indice	TAB	R300
Date	Foglio 20	Segue F 21

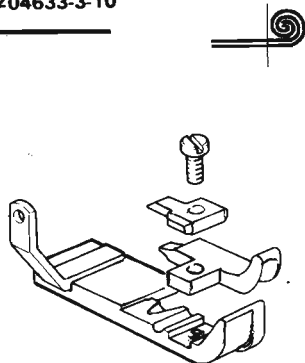
204633-3-10

Serve per
Serves for
Pour machines
Dient fuer

028-00-19
228-00-16

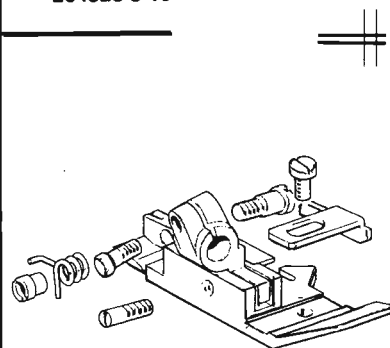
204826-3-10

Serve per
Serves for
Pour machines
Dient fuer

329-00-2CD-03

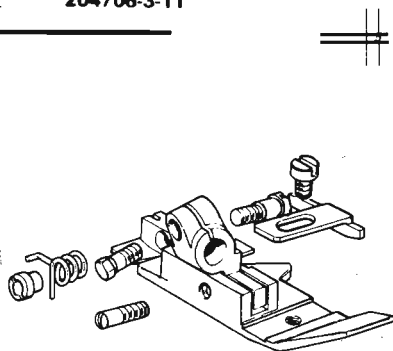
204706-3-11

Serve per
Serves for
Pour machines
Dient fuer

329-00-2CD-02

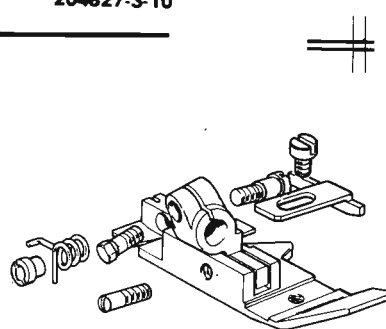
204827-3-10

Serve per
Serves for
Pour machines
Dient fuer

329-00-2CD-04

Si rende noto che il contenuto della presente tavola non potrà essere utilizzato o rappresentato, né comunque che parzialmente senza il permesso scritto della proprietà S.p.A. V. I. DI & C. La stessa intende tutelare i suoi diritti in forma di legge.

modifiche

V.	Indice	Data

Rumoldi

PIEDINO

PRESSER FOOT

PIED PRESSEUR

DRUECKERFUSS

Indice	TAB	R300
Data	Foglio 21	Segue F22

204828-3-10



Serve per
Serves for
Pour machines
Dient fuer

329-22-2CD-02

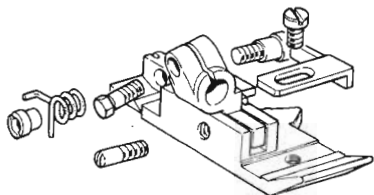

204873-3-11



Serve per
Serves for
Pour machines
Dient fuer

329-12-2CD-02

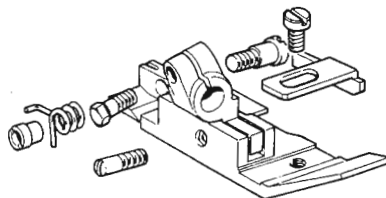

204829-3-10



Serve per
Serves for
Pour machines
Dient fuer

329-23-2CD-02

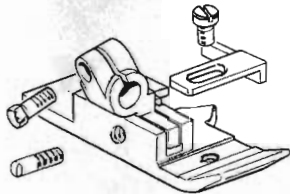

204875-3-11



Serve per
Serves for
Pour machines
Dient fuer

329-22-2CD-03

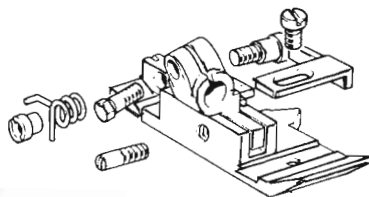

Si rende noto che il contenuto della presente tavola
 non può essere riprodotto o ristampato integral-
 mente o parzialmente senza l'autorizzazione scrit-
 ta della proprietaria S.p.A. Rumoldi & C. La
 stessa intende tutelare i suoi diritti.

Indice
 Data
 Vr

modelli

Rimoldi

PIEDINO

PRESSER FOOT

PIED PRESSEUR

DRUECKERFUSS

Indice		TAB	R300
Date	Foglio 22		

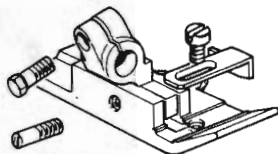
204876-3-11

Serve per
Serves for
Pour machines
Dient fuer

329-23-2CD-03

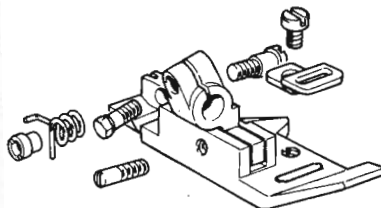
204851-3-11

Serve per
Serves for
Pour machines
Dient fuer

329-01-2CD-01

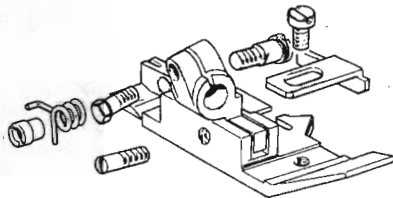
204950-3-11

Serve per
Serves for
Pour machines
Dient fuer

329-00-2CD-01
329-00-2CD-05
329-00-2CD-15

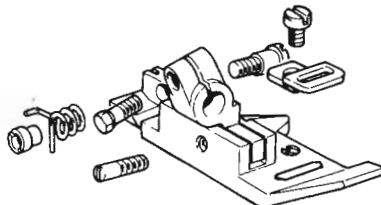
205033-3-11

Serve per
Serves for
Pour machines
Dient fuer

329-01-2CD-02

Si rende noto che il contenuto della presente tavola non potrà essere utilizzato o rappresentato né come disegno né come modello senza l'autorizzazione scritta della proprietaria S.p.A. V. I. I. D. I. & C. La stessa intende tutelare i suoi diritti.

modifiche

Vr	Data	Indice

Rumoldi

PIEDINO

PRESSER FOOT

PIED PRESSEUR

DRUECKERFUSS

Indice	TAB	R300
Data	Foglio 23	Segue F24

205034-3-11

Serve per
Serves for
Pour machines
Dient fuer

329-22-2CD-04

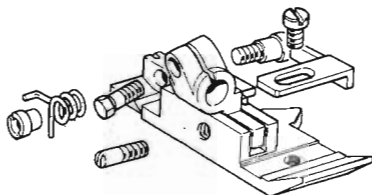
**205070-3-11**

Serve per
Serves for
Pour machines
Dient fuer

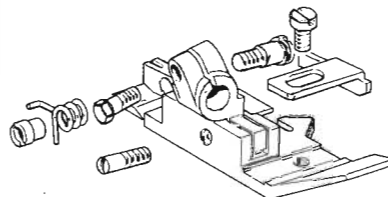
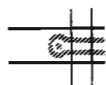
329-00-2CD-06
329-00-2CD-13**205035-3-11**

Serve per
Serves for
Pour machines
Dient fuer

329-23-2CD-04

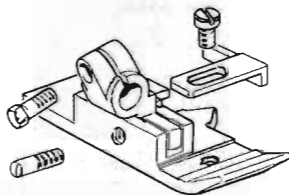
**205084-3-10**

Serve per
Serves for
Pour machines
Dient fuer

329-00-2CD-09

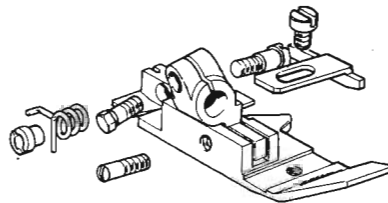

Si rende noto che il contenuto della presente tavola
non è un brevetto, ma è un modello di riferimento
marche di fabbrica, e non può essere copiato o
riprodotto senza permesso scritto dalla Rumoldi & C. La
Rumoldi & C. S.p.A. V.le R. D'Azeglio, 10121 - TORINO
ha riservato tutti i suoi diritti e non intende cedere
nessa intenzione di cedere i suoi diritti.

Indice
Data
V.

modelltech

Rumoldi

PIEDINO

PRESSER FOOT

PIED PRESSEUR

DRUECKERFUSS

Indice	TAB	R300
Date	Foglio 24	Segue F. 25

205085-3-10



Serve per
Serves for
Pour machines
Dient fuer

329-00-2CD-11

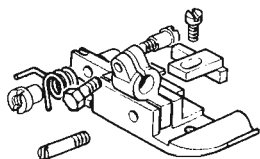

205110-3-11



Serve per
Serves for
Pour machines
Dient fuer

329-00-2CD-07

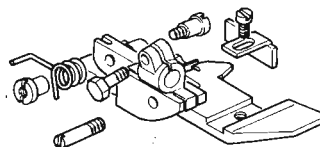

205103-3-10



Serve per
Serves for
Pour machines
Dient fuer

329-00-2CD-08

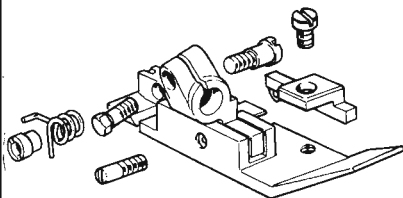

205118-3-11



Serve per
Serves for
Pour machines
Dient fuer

329-00-2CD-10

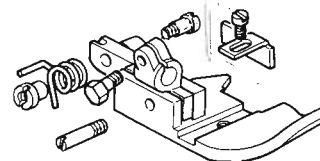

Si rende noto che il contenuto della presente tavola non potrà essere utilizzato o rappresentato né come disegno né come fotografia senza permesso scritto dalla proprietaria S.p.A. V. C. L. D. L. & C. La stessa intende tutelare i suoi diritti secondo le norme di legge.

modifiche

Indice	Data



Remold

PIEDINO

PRESSER FOOT

PIED PRESSEUR

DRUECKERFUSS

Indice				TAB	R300
Data				Foglio 25 Segue F26	

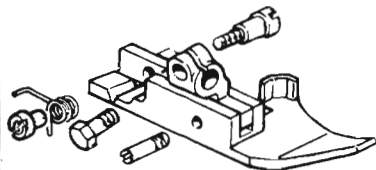
205196-3-10

Serve per
Serves for
Pour machines
Dient fuer

330-00-1CD-01

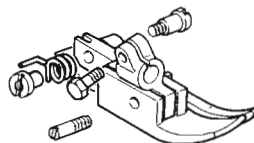
205223-3-10

Serve per
Serves for
Pour machines
Dient fuer

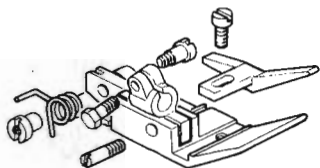
330-00-1CD-02
330-00-1CD-03**205209-3-10**

Serve per
Serves for
Pour machines
Dient fuer

330-00-1CD-02

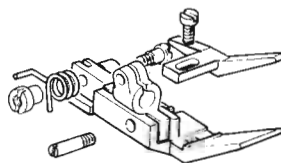
205247-3-10

Serve per
Serves for
Pour machines
Dient fuer

330-00-1CD-03

Si rende noto che il contenuto della presente tavola
 è di esclusiva proprietà della Remold S.p.A. e non
 può essere divulgato, copiato, ristampato, o in
 alcun modo utilizzato senza l'autorizzazione scritta
 della Remold S.p.A. La Remold S.p.A. non si
 assume alcuna responsabilità per i danni di legge.

Indice
 Data
 Vr

modifichim

Remold

PIEDINO

PRESSER FOOT

PIED PRESSEUR

DRUECKERFUSS

Indice	TAB	R300
Data	Foglio 27	Segue F.28

205595-3-10

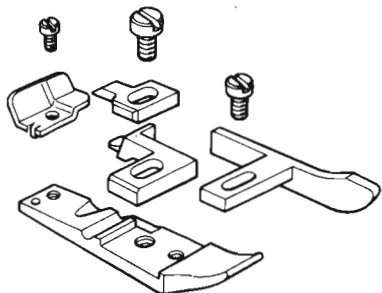

Serve per
Serves for
Pour machines
Dient fuer

327-34-1MD-03

66c

205607-3-00

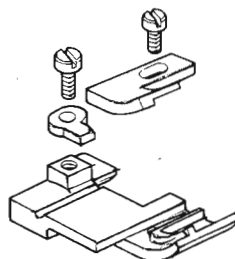

Serve per
Serves for
Pour machines
Dient fuer

327-49-1MD-01

205604-3-00

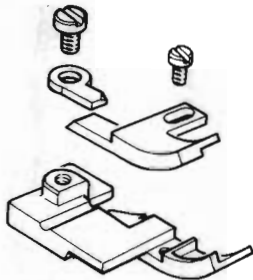

Serve per
Serves for
Pour machines
Dient fuer

327-40-1MD-01

205710-3-00

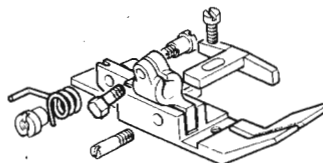

Serve per
Serves for
Pour machines
Dient fuer

330-00-1CD-04

Indice
Data
Vr.

modifiche

Si rende noto che il contenuto della presente tavola è di esclusiva proprietà della Remold S.p.A. e non può essere in alcun modo divulgato, a terzi o riprodotto, sia integralmente che parzialmente senza l'autorizzazione scritta della proprietaria S.p.A. La Remold S.p.A. si riserva espressamente tutti i suoi diritti, come di legge.

Rimoldi

PIEDINO

PRESSER FOOT

PIED PRESSEUR

DRUECKERFUSS

Indice		TAB	R300
Data		Foglio 29 Segue F.30	

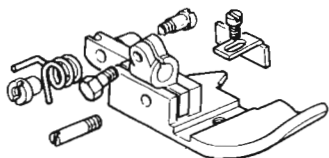
206046-3-01

Serve per
Serves for
Pour machines
Dient fuer

329-00-3MU-01

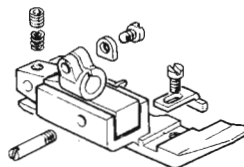
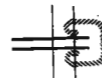
206231-3-00

Serve per
Serves for
Pour machines
Dient fuer

330-12-2CD-02

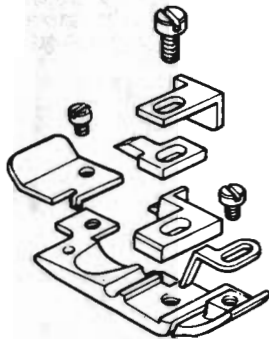
206140-3-00

Serve per
Serves for
Pour machines
Dient fuer

327-34-1CD-01

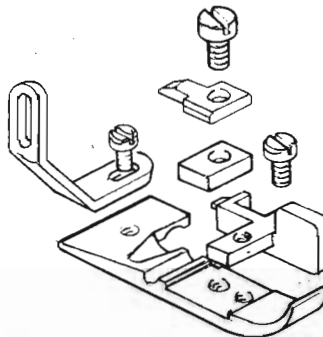
207046-3-00

Serve per
Serves for
Pour machines
Dient fuer

327-11-1CD-02

Indice
Data
V.:

modifiche

Si rende noto che il contenuto della presente tavola è di esclusiva proprietà della Rimoldi S.p.A. e non può essere in modo alcuno divulgato a terzi o riprodotto, in tutto o in parte, senza il permesso scritto della Rimoldi S.p.A. Rimoldi S.p.A. si riserva espressamente il diritto di tutelare i suoi diritti in ogni forma di legge.

921396-3-10

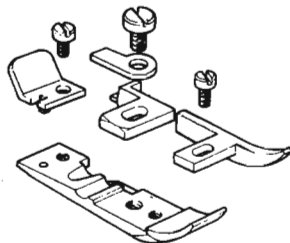

Serve per
Serves for
Pour machines
Dient fuer

- 327-28-1CD-02/135-81
- 327-28-1CU-04/135-81
- 028-28-01/135-80
- 028-28-02/135-80
- 028-28-04/135-80
- 228-28-01/135-80
- 228-28-02/135-80
- 228-28-04/135-80

921404-3-10

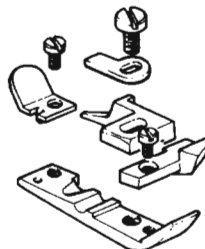

Serve per
Serves for
Pour machines
Dient fuer

- 327-10-1CD-03/135-81
- 327-10-1CD-04/135-81
- 228-10-02/135-80
- 228-10-03/135-80

921403-3-10

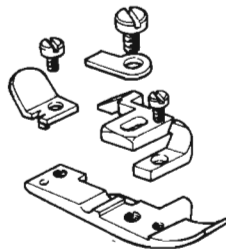

Serve per
Serves for
Pour machines
Dient fuer

- 327-10-1CD-02/135-81
- 327-10-1CD-06/135-81
- 028-10-02/135-80
- 028-10-03/135-80
- 028-10-04/135-80
- 028-10-05/135-80
- 228-10-01/135-80
- 228-10-05/135-80
- 228-10-06/135-80
- 228-10-07/135-80

921417-3-10

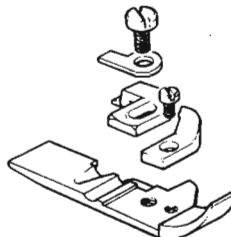

Serve per
Serves for
Pour machines
Dient fuer

- 327-00-1CD-25/135-81

Si rende noto che il contenuto della presente tavola non potrà essere utilizzato o riprodotto senza permesso né comunque divulgato a terzi o ristampato integralmente senza autorizzazione scritta della proprietaria S.p.A. V. V. OLIO S. C. S. La stessa invade tutelare i suoi diritti a norma di legge.

modifiche

Indice	Data	Vr



Rimoldi

PIEDINO

PRESSER FOOT

PIED PRESSEUR

DRUECKERFUSS

In d i c e				T A B E L L A	R 300
Data				Foglio 35	Segue F.36

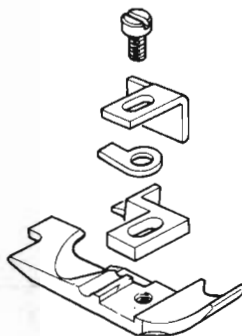
921422-3-10

Serve per
Serves for
Pour machines
Dient fuer

327-00-1CD-06/135-81
028-00-02/135-80
228-00-04 /135-80

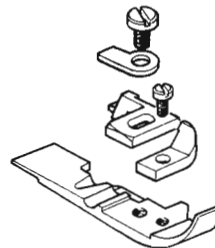
921437-3-10

Serve per
Serves for
Pour machines
Dient fuer

327-28-1CD-11/135-81
028-00-08/135-80
228-00-08/135-80

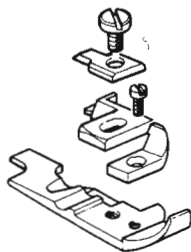
921426-3-10

Serve per
Serves for
Pour machines
Dient fuer

327-00-1CD-31/135-81
228-00-15/135-80

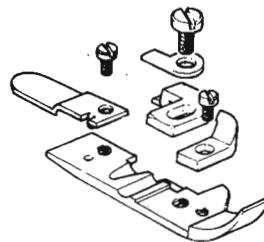
921438-3-10

Serve per
Serves for
Pour machines
Dient fuer

327-00-1CD-09/135-81/137-81
327-00-1CD-39/135-81/137-81
028-00-06/135-80/137-80
228-00-06/135-80/137-80
228-00-17/135-80/137-80

Indice
Data
Vr

Indice
Data
Vr

Si rende noto che il contenuto della presente tavola
non è destinato a essere divulgato a terzi o riprodotto
integralmente o parzialmente senza l'autorizzazione scritta
della stessa azienda tutelare i suoi diritti a norma di legge.

921439-3-10

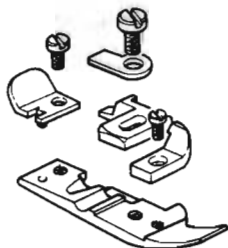

Serve per
Serves for
Pour machines
Dient fuer

327-00-1CD-10/135-81/137-81
028-00-07/135-80/137-80
228-00-07/135-80/137-80

921453-3-10

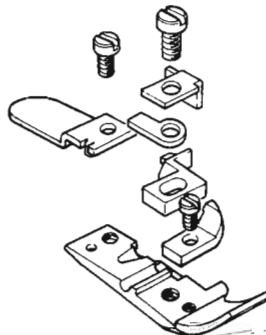

Serve per
Serves for
Pour machines
Dient fuer

327-00-2CD-12/135-81
327-00-2CD-18/135-81/137-81
327-00-2CD-34/135-81/137-81
028-00-09/135-80/137-80
228-00-09/135-80/137-80

921440-3-10

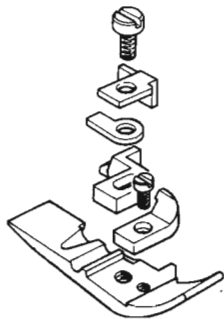

Serve per
Serves for
Pour machines
Dient fuer

327-28-1CD-07/135-81
028-28-07/135-80
228-28-07/135-80

921455-3-10

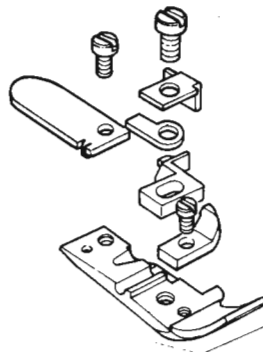

Serve per
Serves for
Pour machines
Dient fuer

327-00-2CD-13/135-81/137-81
028-00-10/135-80/137-80
228-00-10/135-80/137-80

Si rende noto che il contenuto delle presentate tavole non potrà essere utilizzato o riprodotto senza permesso scritto dalla Rumoldi S.p.A. e che per l'uso di queste tavole si integrano le istruzioni scritte nella stessa. Intende tutelare i suoi diritti e norme di legge.

modifiche

V.	Data	Indice

Remoldi

PIEDINO

PRESSER FOOT

PIED PRESSEUR

DRUECKERFUSS

Indice		T.A. 81	R300
Data	Foglio 37		

921530-3-11



Serve per
Serves for
Pour machines
Dient fuer

228-00-18/135-80/137-80

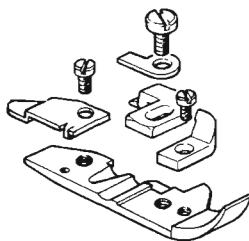

923839-3-00



Serve per
Serves for
Pour machines
Dient fuer

327-28-1CD-09/135-81
228-28-10/135-80

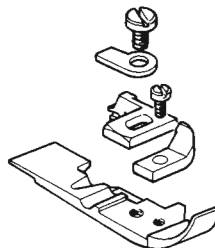

923783-3-00



Serve per
Serves for
Pour machines
Dient fuer

327-00-1MD-23/135-81
028-00-18/135-80

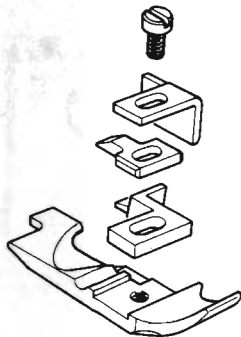

923880-3-00



Serve per
Serves for
Pour machines
Dient fuer

327-00-2CD-41/135-81

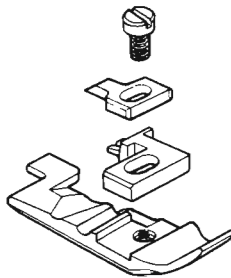

Indice
Data
V.
Modifiche

Si rende noto che il contenuto della presente tavola non potrà essere utilizzato, appreso, riprodotto, o comunque divulgato a terzi o riprodotto integralmente o parzialmente senza l'autorizzazione scritta della stessa Remoldi, che si riserva il diritto di legge di tutelare i suoi diritti.

Rimoldi

PIEDINO

PRESSER FOOT

PIED PRESSEUR

DRUECKERFUSS

Indice	TAB	R300
Date	Foglio	38 Segue F 39

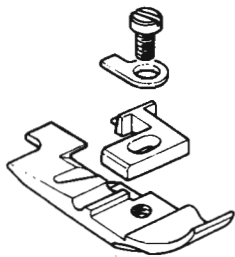
923885-3-00

Serve per
Serves for
Pour machines
Dient fuer

327-00-2MD-36/135-81
028-00-16/135-80

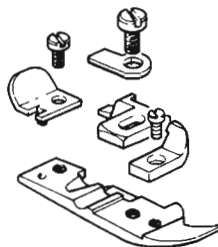
923901-3-00

Serve per
Serves for
Pour machines
Dient fuer

028-00-01/135-80
228-00-01/135-80

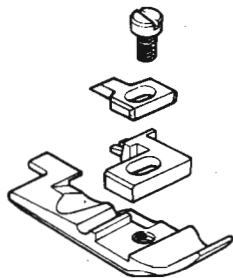
923887-3-00

Serve per
Serves for
Pour machines
Dient fuer

327-00-2MD-20/135-81
028-00-17/135-80

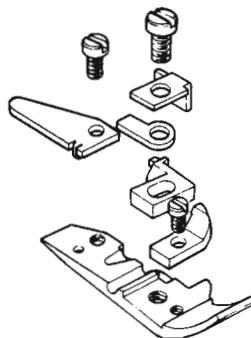
923910-3-00

Serve per
Serves for
Pour machines
Dient fuer

327-00-1CD-09/135-81/137-81
327-00-1CD-39/135-81/137-81
028-00-06/135-80/137-80
228-00-06/135-80
228-00-17/135-80

Si vende noto che il contenuto della presente tavola non potrà essere utilizzato a terzi o riprodotto senza autorizzazione della proprietaria S.p.A. V. D. I. & C. La stessa intende tutelare i suoi diritti in base alla normativa di legge.

modifich.

Indice	Data
V/	

